



it is time for perfection...



outdoor indoor
security door
style of

2023

www.falezcelikkapi.com

FALEZ CELİKKAPI sektöründeki 20 yılı aşkın ecrübesi ile, başta 150 9001 kalite yönetim sistemi olmak üzere ulusal TSE [TS 12655] ve uluslararası DIE HOLZFORSCHUNG AUSTRIA [EN 1627 VE DIN 1627 TYP EUROPA], GOST, SONCAP sertifikalarıyla, Antalya'da toplamda 20 bin metrekarelik tesislerinde üretime devam etmektedir.

Türkiye'de çelikkapı konusunda birçok ilke imza atarak sektörün en geniş yurtiçi ve yurtdışı bayi ağına sahip firmalarından biri haline gelmiştir. Liderlik ve müşteri memnuniyeti için; yenilikçi, estetik ve kaliteli üretimde olduğunun bilincinde olan firmamız ar-ge departmanına yapmış olduğu büyük yatırımların sonuçlarını almaktadır. Sahip olduğu know - how ile ürettiği kapı yüzeyleri, korozyona % 100 dayanıklı, angın sertifikalı, Yüksek yüzey mukavemetli, geniş üretim çeşitliliği ile müşteri memnuniyetini en üst seviyeye çıkarmaktadır. Güvenlik ve sağlam bir ürün almak hem felsefi, hem hukuksal hem de sosyal bağlamda bir ayrıcalık değil, herkesin sahip olması gereken temel haktır. Aralıksız devam eden ar-ge çalışmaları ile, otomasyonlu üretim yapan, ihtiyacı olan makine parkını da kendi üreten ve kullanan ilk ve tek firma olma özelliğine sahiptir. Bu eşsiz hizmet kalitesi ile üretilen, yüksek güvenli ürünü özelliklerine sahip, uzun yıllar sonucu oluşmuş haklı bir marka bilinirliğine sahip!

İnsanımız değerlidir prensibi ile yola çıkan Falez Celikkapı,hizmet içi eğitimleri ile yönetim ve üretim departmanı personellerinin bilgi ve becerilerini arttırmayı görev edinmiştir. Bunun sonucu olarak iş bilinci yüksek, verimli ekibi ile ürün kalite ve yelpazesini geliştirmektedir. Sektöründeki tecrübesiyle; emin adımlar ile ilerlemekte ve sektörün gelişmesinde lokomotif görevini üstlenmektedir.

Bizi bugün olduğumuz lider konumuna getiren prensibimiz; değerlerimize bağlı kalmamız ve dürüstlük ilkesini her zaman benimsememizdir. Bu başarıya katkı sağlayan çalışanlarımızla, bayilerimizle ve müşterilerimiz ile birlikte büyüyerek, üretimimize devam etmek ve en iyi hizmeti vermek hedefimizdir.

Saygılarımızla
Falez Celikkapı Yönetim Kurulu

ÇELİKKAPI ALIRKEN SORULMAMASI GEREKEN 3 SORU

- 1 Bu kapı kaç kilogram?**
Genelde çelik kapı alırken sıklıkla ilk sorduğumuz sorudur, ama yanlış bir sorudur. Kapının genelde ağırlığını kapıların iki yüzüne de monte edilen ahşap veya mdf yüzeyler oluşturur. Görsellik için dekoratif amaçlı kullanılan bu malzemelerin güvenlik ve sağlamlıkla ilişkisi olmadığı gibi, yük olmaktan başka fayda sağlamaz. Bunun doğrusu dekoratif yüzeyler çıkarıldığı zaman kalan çelik konstrüksiyonu ve tekniğinin bir çelik kapı özelliği taşıyıp taşımadığıdır.
- 2 Bu kapıyı hırsız açar mı?**
Bu soru da çok sorulur ki satıcıyı çok zor durumda bırakır. Unutulmamalıdır ki hiç bir satıcı çelik kapıyı hırsız açar diye satamaz. Bu soru için de alttaki test ve teknik bölümümüzü okumanızı tavsiye ederiz.
- 3 Kapı kanadının kalınlığı nedir?**
Çelik kapılar 5-9 cm kalınlığında dolu çelikten yapılmazlar. Zaten bu kalınlıkta dolu çelikten yapılan bir kapıyı hiç bir yapı da taşımaz. Bu soru da yanıltıcı bir soru olup, asil olan yine kapının nasıl yapıldığıdır.

ÇELİKKAPI ALIRKEN SORULMASI GEREKEN 3 SORU

- 1 Çelik kapının kanat ve kasa bölümünün özellikleri nelerdir? Görsel MDF ve benzeri parçalar olmadan kapıyı veya kesidini görebilir miyim?**
- 2 Çelik kapının yapımında kullanılan malzemelerin özelliği, kalınlığı ve dayanımını öğrenebilir miyim?**
- 3 Hırsızlık ve dayanımı için çelik kapının ne tür önlemleri ve özellikleri olduğunu öğrenebilir miyim?**

EĞER MAL GÜVENLİĞİ YANINDA AİLENİZİN VE KENDİNİZİN CAN GÜVENLİĞİNİ DE ÖNEMSIYORSANIZ

Falez çelik kapının tasarladığı dünyada bir ilk olarak yapılan patentli can güvenliği kapısını inceleyin. Bu kapı sizin ve ailenizin mal güvenliğine ilave olarak can güvenliğini de koruma amaçlı üretilmiştir. Araştırmalarda genelde hırsızlıklar siz evinizde yokken meydana gelmektedir. Buradaki kayıp hem maddi hem de manevi olabilmektedir. Can güvenliği kapımız ise siz evinizdeyken sizi korur.Bu günlerde genelde haberleri takip ettiğimiz zaman özellikle büyük şehirlerde gasp olayları çoğalmıştır. Kötü niyetli insanlar evin kapısını bir bahane ile açtırtmaktadır. Bunun için bir çok seneryo üretebilirler genelde bunlar satıcı bahanesi olmaktadır.Evin maddi durumunu ve evdeki kişilerin azlığını takip edebilirler.Biz iyi niyetli olarak en güvenli kapımız,dahi olsa araladığımız zaman zaten hazırlıklı olan kişi evin ,çerisine görebiliyor o anda en güvenli hepimizin mahremi olan evimiz en güvensiz hale geliyor. Çünkü dışarıda bir tarlada bile insan birisine bir şey yapmaya kalkışsa kendisinin farketmediği üçüncü kişilerin göreceğinden çekenebilir. Ev ise kapalı bir kutudur o anda can güvenliğimiz tehdit altına alınabilir. Bu tür problemlerin yaşanmaması için tasarladığımız can güvenliği kapısının, tek bir kapı kanadı görünümünde fakat istenildiğinde iki parçaya ayrılabilen bir özelliği vardır. Bu sayede bir satıcı veya tanımadığınız birisi kapınızı çaldığı zaman kapınızın tamamını açmaya gerek kalmadan rahatlıkla konuşabilir ve alış veriş yapabilirsiniz

Daha fazla bilgi sahibi olmak ve inceleyebilmek için sitemizde bulunan reklam filmini izlemenizi tavsiye ederiz.

Tüm Serilerimizde Güvenlik Üzerine Olan Üstünlüklerimiz ve Bazı Hırsızlık Yöntemleri

1. Kapı kasaları kriko, levye vb. aletler yardımıyla genişletilerek kilitlere ulaşılmaya çalışılır. Kapı kasalarımızda 2 mm. çelik ve atıklar-la bu durum engellenir. Aynı yöntem ile kapı kanadı sıkıştırılmaya çalışılır. Yekpare kanat ve yüksek tonajlı pres uygulamasıyla da Falez Celikkapı yatayda sıkıştırılması en zor sisteme sahiptir. Teknik olarakta 1 metre eninde 2 levha çelik sacı sıkıştırmak, bir profil sistemini sıkıştırmaktan üstün olacaktır.
2. Yine levye veya tornavida ile kanadı egerek kilit sistemine ulaşmaya çalışılır. Falez Celikkapı olarak başta yüksek tonajlı preslerle yekpare kapı kanadı elde edilir. Kapımızın içine de 45 dansite yoğunluğunda ve yüksek yapışma özelligine sahip poliüretan dolgu konulmaktadır. Bu sayede 40 ton gb. Yüzey , 10 ton gb. eglmeme mukavemetine sahip bir kapı yapılmaktadır.
3. Kapı kilit sisteminin kalınlığı, çokluğu ve fonksiyonu ne olursa olsun, kilit mekanizmalarını çalıştıran anahtar vasıtasıyla çalışan barel mekanizması hırsızlık için ulaşılması en zor detay olmalıdır. Çünkü hırsızlık için barele ulaşılması kilit sistemini başka barel vb. aletlerle kolaylıkla açılması söz konusudur. Bunun için de Falez Celikkapı için özel tasarlanmış çelik zırhımız, bunu çeken özel kalın çektirme vida sistemimiz ve kapı içi takviyelerimiz bulunmaktadır.
4. Kapı üzerine büyük darbe vurulması yöntemi de bir hırsızlık yöntemi olup, parçalı olmayan ve içindeki poliüretan uygulamasıyla Falez Celikkapı Sistemi üstünlüğü artmaktadır. Kilit sistemi olarak Kancalı, merkezi kilit sistemi, kumandalı ve parmak izli bütün kilit sistemleri kullanılmaktadır.

FALEZ ÇELİK KAPI, with its experience in the industry over 20 years, carries out manufacturing activities in an area of 20.000 m2 in total in Antalya, in accordance with quality certificates including 150 9001 quality management system, national TSE (TS 12655) and international DIE HOLZFORSCHUNG AUSTRIA (EN 1627 and DiN 1627 CIP EUROPA), GOST, SONCAP. The company pioneered in many aspects of steel door industry in Turkey, and has become one of the companies that has industry's most extensive dealer network in the domestic and overseas markets. Our company is aware that the leadership and customer satisfaction lies in innovative, aesthetic and high quality production, and reaps the results of the huge investments that are made in our R & D department. The door panels, manufactured with our know-how maximize customer satisfaction with 100% corrosion-resistance, fire-proof quality, high surface strength a wide variety of production. Safety and purchasing a robust product is not a privilege, but a fundamental right that everyone should have, in philosophical, legal and social context.

Our company, with continuous R & D efforts, is the first and only company with automated production process, producing and using its own machinery. So it has the high brand recognition as a result of many years work, with a unique quality of service, high security product features. Falez celik Kapi set out with the principle "our people arevaluable", and is committed to increasing the knowledge and skills of its management and production department staff with in-service training. As a result, an efficient staff with high business awareness develops the quality and range of products. Falez Çelik Kapi, with its experience in steel door sector, is advancing with sure steps and act as an engin in the development of the sector. The most basic principle that put us today in a leading position is sticking to our values and the adoption of principle of honesty. Our goal is to grow together with our employees, dealers, and customers, who are contributing to our success, and to continue to give the best service.

Sincerely
Falez Çelikkapi Executive Board

3 QUESTIONS NOT TO ASK WHEN BUYING A STEEL DOOR

- 1 How much does this door weigh?**
This is the first question we ask usually when we buy steel door, but it is a wrong question. Because the weight of the door consists usually of wooden and mdf surfaces mounted on both sides of the door. Since these materials are used for decorative purposes and don't relate to the safety and robustness, its only a useless load. In fact, it should be asked whether remaining steel construction and technique could have a steel door feature when decorative surfaces are removed.
- 2 Can a thief open this door?**
This question is also asked very often, that leaves the dealer in a difficult situation. You must keep in mind that no seller can sell a steel door which he says that a thief can open it. For this question, we recommend that you read the following test and technical section.
- 3 What is the thickness of the door leaf?**
Steel doors aren't made of 5-9 cm thick steel. In fact, no structure can carry a door made of steel with full thickness. This question is misleading and the real question is how the door is made of.

3 QUESTIONS TO ASK WHEN BUYING A STEEL DOOR

- 1 What is the technical specification of the door leaf and frame?
Can I see the door or the cross section without MDF and similar decorative parts?**
- 2 Can you tell properties, the thickness and strength of the materials used in the construction of the steel door?**
- 3 Can you tell anti-theft measures, strength and properties of the steel door?**

For security, theft, robustness, it should be asked the construction and technical characteristics of the door. We recommend that you read the following safety specifications and technical characteristics below. In all our series, security advantages and anti-theft measures:

1) Door frames are expanded with the help of jack, lever and similar tools for reaching the locks. In our door frames, this situation is prevented with 2 mm steel and wefts. With the same method, the thieves try to block the door leaf. With bucket wings and high-tonnage pressing methode, Falez Steel Door has also the most difficult system to block in horizontal. Technically, compressing 2 steel plates with 1 meter wide-ness would be superior than compressing a profile system.

2)Again, the thieves try to reach the lock system by tilting the leaf with a crowbar or screwdriver. At Falez celik Kapi, we manufacture first the massive door leaf in high tonnage presses. The door is filled with polyurethane sealant that has a 45th density and high adhesion. In this way, we manufacture a door with 40 tons gb surface strength and 10 tons gb , 10 tons bending strength.

3) Regardless the function, the thickness and the number of the door lock system, the barrel mechanism running through the key turning the locking mechanism should be the most difficult detail to reach for theft. Because if the thieves reach the barrel, they can easily open the locking system with another barrel etc. For this reason, we specially designed our steel armor, a special puller screw system and the indoor supports for Falez Steel Door.

4) Applying a major blow on the door is another method of theft, Falez Steel Door System, with massive structure and polyurethane filling proves its superiority. For locking mechanism, hook lock, central locking system, remote controlled and fingerprint locking systems are being used.

IF YOU CARE ABOUT LIFE SECURITY OF YOU AND YOUR FAMILY IN ADDITION TO SECURITY OF YOUR PROPERTY: Please check the licensed life security door designed by Falez Celikkapi as a first in the world. This door has been produced for protecting life security of you and your family in addition to the security of property of you and your family. Researches show that burglaries generally occur while you are outside the house. What is suffered here may be either pecuniary loss or intangible damages. Our life security door protects you when you are home. As you are watching the news recently you obviously see that ratio of extortion cases is gradually rising especially in metropolitan cities. Malicious people are able to get your door opened with any excuse. A number of scenarios may be generated for this; being the "seller" may be the most common. They may monitor the financial status in the house or number of people living in concerning house. Even if we have the safest door, as we slightly open the door being well-intentioned, they may get inside the house being already prepared. Then, our house where is our safest private place may become the place of least security. That is because even if a person intends to do harm to a third part in a field outside, they may hold off being afraid to be seen by others who they have not noticed. Yet, house is a closed box; your life may get under threat in a wink. The life security door that we have designed for avoiding such problems has a feature of splitting in two parts when desired while appearing as one single door leaf. Therefore; when a seller or someone you do not know knocks your door, you may talk to or exchange things with him without opening your door fully. We recommend you to watch the commercial film on our web site for more information and checking it out.



Uluslararası standartlara ulaşarak etkin bir kalite yönetim sistemi oluşturmak üzere şirketimize değer katacak belgelere sahibiz.

Kalite odaklı yaklaşımımız sayesinde tüm süreçlerimizi alanında uzman ekiplerimizle yönetiyor, müşteri memnuniyetini en üst düzeyde tutuyoruz.





OUR CE CERTIFICATES



Classification Standards
Rw (C;Ctr) dB
29 (0; -1)



Classification Standards
PN-EN 14351-1+A2
2,1



Classification Standards
PN-EN 12207
2



Classification Standards
PN-EN 12208
1A



Classification Standards
PN-EN 12210
C3



Classification Standards
ALL STEEL (CLASS A), ONE LEAF
WING SIZE TYPE 1, SEALED
ANTI THEFT STEEL DOOR (CLASS 3)



CAM SERİSİ GLASS SERIES

* Ürün seçenekleri için yer aldığı kategoriye göz atabilirsiniz.
* You can browse the category for the product options.



DLX 101
Ultra
Ultra

PİVOT SERİSİ PIVOT SERIES

* Ürün seçenekleri için yer aldığı kategoriye göz atabilirsiniz.
* You can browse the category for the product options.



PVT 103
Cam Ral 7016
Glass Ral 7016

NEOCLASSIC SERİSİ NEOCLASSIC SERIES

* Ürün seçenekleri için yer aldığı kategoriye göz atabilirsiniz.
* You can browse the category for the product options.



NCS 105
Britanya Kırmızı
Britania Red

PRESTİJ SERİSİ PRESTIGE SERIES

* Ürün seçenekleri için yer aldığı kategoriye göz atabilirsiniz.
* You can browse the category for the product options.



PR 111 Semi DB 94 / DB 13
Açık Altın Meşe / Grafit Gri
Light Gold Oak / Graphite Grey



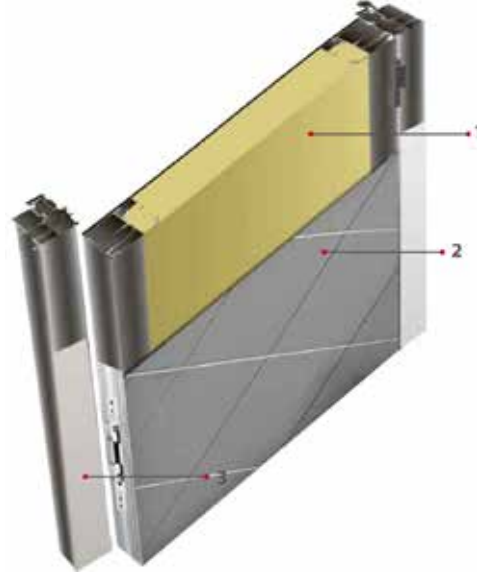

- 1- **Poliüretan Dolgu**
Filled by with Polyurethane
- 2- **Temperli Cam Yüzey**
Tempered Glass Surface
- 3- **Alüminyum Kasa**
Aluminium Frame



FALEZ PIVOT



PVT 102
Falez Pivot Serisi
DB 90
Zen Kalın Altın Meşe | Zen Line Wood



KASA
- 2 mm galvaniz çelik

KANAT
- 1,2 mm X 2 yeypare galvaniz çelik
- Dış ortam koşullarına dayanıklı yüzey
- 70 kg/m³ yoğunluklu taş yünü dolgu
- Monoblok kilit sistemi
- 180 cm Krom yada alüminyum kare kol
- Kanat etrafı dekoratif elokssallı alüminyum çita
- Özel Falez pivot menteşe
- Kanat Kalınlığı: 74 mm

DOOR FRAME
- It is made from 2 mm galvanized steel

DOOR LEAF
- It is made from 1,2 mm two monolith plates galvanized steel
- Special coating over front steel leaf
- Inside door leaf is filled by 70 kg/m³ density rockwool
- Monoblock locking system
- Chromium or Aluminium quadratic 180 cm door handle
- Special Falez pivot hinges
- Around door leaf is designed by special anodized aluminium
- Leaf Thickness: 74 mm



DB - 98
Koyu Abanoz
Dark Ebony



DB - 99
Açık Abanoz
Light Ebony



DB - 86
Antik Bambu
Antique Bamboo



DB - 95
İnce Ceviz
Nussbaum



DB - 90
Kalın Altın Meşe
Line Wood



DB - 91
İnce Altın Meşe
Fine Wood



DB - 93
Tik
Teak



DB - 94
Açık Altın Meşe
Kiefer Line Wood

PVT 105
Falez Pivot Serisi
Seramik Mokka
Ceramic Mocha



Seramik Metalik Kıvıllı
Ceramic Metallic Red



Seramik Mokka
Ceramic Mocha

PVT 104
Falez Pivot Serisi
Doğal Ağaç
Natural Wooden



falezçelikkapı

PVT 103
Falez Pivot Serisi
Cam RAL 7016
Glass RAL 7016



SERTİFİKALARIMIZ
CERTIFICATES



Darbeye Dayanır
Impact Resistant
40 Tonne



Eğilmeye Dayanır
Bow Resistance
5 Tonne



Dayanıklı Ön Zırh
Durable Front Armor



Ayarlı Menteşe
Adjustable Hinge



Çevre Dostu
Eco-Friendly



Çizilmeye Karşı
Dayanıklı Yüzey
Surface Resistance
To Scratching



E60, EI45
E60 - EI45



Neme Dayanıktır
Resistant To Moisture



Ses İzolasyonu
Sağlayan Özel Yapı
Special Structure That
Provides Sound Insulation



Isı İzolasyonu
Sağlayan Özel Yapı
Special Structure
Provides Heat
Resistance Isolation



Rüzgara Dayanıklı
Resistance to wind load



Cam RAL 7016
Antrasit Gri
Glass RAL 7016
Anthracite Gray



Cam RAL 9010 Beyaz
Glass RAL 7016 White

Tüm RAL renk kodları uygulanabilir.
All RAL color codes are applicable.

PIERRE



PR 102
Pierre Serisi
Semi Taş - Cam Antrasit
Semi Taş Glass Anthracite



Dış Çeşme İçin Uygundur
Güneşe Dayanır
Sarılaşma Riski Yoktur



PR 101
Pierre Serisi
Piano Antrasit - Tütün
Piano Anthracite - Tobacco



Dış Çeşme İçin Uygundur
Güneşe Dayanır
Sarılaşma Riski Yoktur

KASA

- 2 mm galvaniz çelik
- 18 - 24 cm duvar kalınlığı
- 24 cm ve üzeri özel ölçü
- Kasa içi dekoratif eloksallı alüminyum profil

OPSİYONEL

- Alüminyum & Ahşap kasa kaplama seçeneği

KANAT

- 1,2 mm X 2 yekpare galvaniz çelik
- Dış ortam koşullarına dayanıklı taş yüzey
- 42 densite poliüretan dolgu
- Merkezi 14'lü kilit sistemi
- 6 adet sabit emniyet pimi
- Gizli emniyet kelepçesi
- 50 cm Krom yada alüminyum kare kol
- Kanat etrafı dekoratif eloksallı alüminyum çita
- Geniş açılı lüks dürbün
- Kaynaksız ayarlı menteşe
- Kanat Kalınlığı: 100 mm

DOOR FRAME

- It is made from 2 mm galvanized steel
- Frame can be adjusted to 18 cm - 24 cm wall thickness
- Special manufacturing for over 24 cm
- inside frame has decorative eloxal aluminium profile

OPTIONAL

- Electrostatic powder paint

DOOR LEAF

- It is made from 1,2 mm two monolith plates galvanized steel
- Special natural stone coating over front steel leaf
- Inside door leaf is filled by 42 density polyurethane
- 14 point central locking system
- 6 pieces stable safety pin
- Hidden safety clips
- Chromium or Aluminium quadric 50 cm door handle
- Luxury peephole
- Weldless adjustable hinges
- Around door leaf is designed by special anodized aluminium
- Leaf Thickness 100 mm



PR 102 Double
Pierre Serisi
Piano Antrasit - Cam - Taş - DB 94 Açık Altın Meşe
Piano Antrasit - Glass - Stone - DB 94 Kiefer Line Wood



PR 103
Pierre Serisi
Copper Double Kanatlı
Copper Double Leaf Door

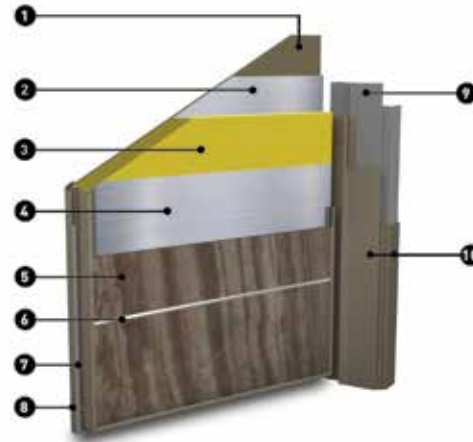

- | | | | |
|---|---|----|--|
| 1 | MDF Arka Yüzey
MDF Surface Back steel Over | 4 | Alüminyum W Çita
Aluminum Joint Accessory |
| 2 | 1,2 mm Yıkılgan Galvaniz Çelik
1,2 mm Solid Galvanized Steel | 5 | İzolasyon Filtresi
Insulation Basket |
| 3 | 42 Densite Polüretan Dolgu
42 Density Polyurethane Filler | 6 | |
| 4 | 1,2 mm Yıkılgan Galvaniz Çelik
1,2 mm Solid Galvanized Steel | 7 | 2 mm Galvaniz Çelik, Elektrotatik Toz Boya
2 mm Galvanized Steel Electrostatic Powder Paint |
| 5 | Özel Değerli Taş Yüzeyi
Special Stone Surface | 8 | Alüminyum Kasa Perçes Kaplama
Aluminum Frame Trim |
| 6 | | 9 | |
| 7 | | 10 | |
| 8 | | | |



Bakır
Copper



Antrasit
Anthracite

SERTİFİKALARIMIZ
CERTIFICATES



CERAMIC

KASA

- 2 mm galvaniz çelik
- 18 - 24 cm duvar kalınlığı
- 24 cm üzeri özel üretim
- Kasa içi dekoratif eloksallı alüminyum profil

OPSİYONEL

- Alüminyum & Ahşap kasa kaplama seçeneği

KANAT

- 1,2 mm x2 yekpare galvaniz çelik
- Çelik üzeri dış cepheye dayanıklı seramik yüzey
- 42 densite poliüretan dolgu
- 14'lü kilit sistemi
- 6 adet sabit emniyet pimi
- Gizli emniyet kelepçesi
- Özel Krom yada alüminyum çekme kolu
- Kanat etrafı dekoratif eloksallı alüminyum çıta
- Geniş açılı lüks dürbün
- Kaynaksız ayarlı menteşe
- Kanat Kalınlığı 100 mm

DOOR FRAME

- It is made from 2 mm galvanized steel
- Frame can be adjusted to 18 cm - 24 cm wall thickness
- Special manufacturing for over 24 cm
- Inside frame has decorative eloxal aluminium profile

OPTIONAL

- Electrostatic powder paint

DOOR LEAF

- It is made from 1,2 mm two monolith plates galvanized steel
- Ceramic stone coating suitable for exterior surface on steel
- Inside door leaf is filled by 42 density polyurethane
- 14 point central locking system
- 6 pieces stable safety pin
- Hidden safety clips
- Chromium or aluminium door handle
- Luxury peephole
- Weldless adjustable hinges
- Around door leaf is designed by special anodized aluminium
- Leaf Thickness 100 mm



CRM 101 Seramik Serisi Metalik Kızıl Metallic Red



Dış Cephe İçin Uygundur
Güneşe Dayanır
Suitable for Exterior Facade

CRM 102 Seramik Serisi Mokka Mocha



Dış Cephe İçin Uygundur
Güneşe Dayanır
Suitable for Exterior Facade

Kesit Görünüşü | Section View

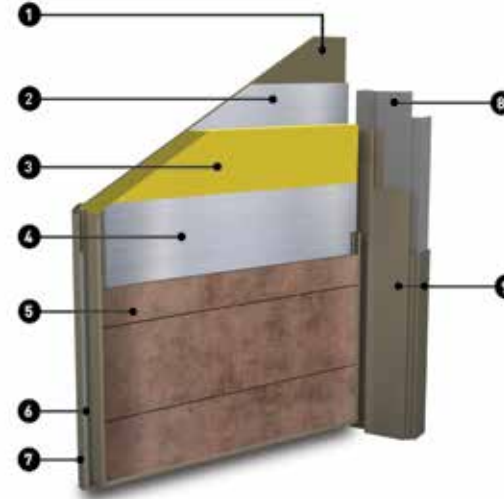

- | | | | |
|---|--|---|---|
| 1 | MDF Arka Yüzü
MDF Surface Above Steel Over | 6 | İzolasyon Fibrili
Insulation Gasket |
| 2 | 1,2 mm Yekpare Galvaniz Çelik
1,2 mm Solid Galvanized Steel | 7 | Kanat Etrafı Eloksallı Alüminyum Çıta
Anodized Aluminium Profile Around the Door Leaf |
| 3 | 42 Densite Poliüretan Dolgu
42 Density Polyurethane Filler | 8 | 2 mm Galvaniz Çelik, Elektrostatik Toz Boya
2 mm Galvanized Steel Electrostatic Powder Paint |
| 4 | 1,2 mm Yekpare Galvaniz Çelik
1,2 mm Solid Galvanized Steel | 9 | Alüminyum Kasa Perdesi Kaplama
Aluminium Frame Trim |
| 5 | Özel Doğal Seramik Yüzey
Special Ceramic Surface | | |



Mokka
Mocha

Antrasit
Anthracite

Metalik Kızıl
Metallic Red

SERTİFİKALARIMIZ
CERTIFICATES



40 Tonne



5 Tonne



Adjustable Hinge



Eco-Friendly



Surface Resistance To Scratching



CE



600 - 640



Resistant To Moisture



Special Structure That Provides Sound Insulation



Special Structure That Provides Heat Resistance Isolation



Resistance to wind load

WOODEN

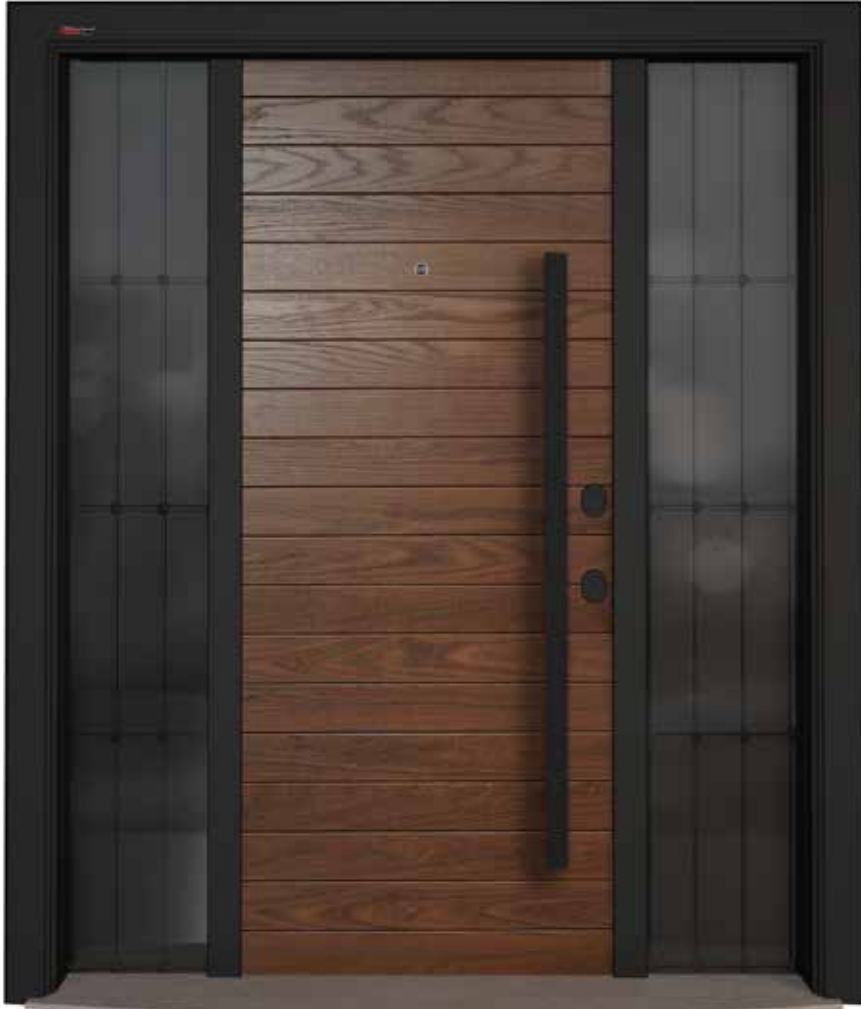

WDN 100

Wooden Serisi
Noble Doğal Ağaç
Noble Natural Wood



KASA

- 2 mm galvaniz çelik
- 18 - 24 cm duvar kalınlığı
- 24 cm üzeri özel üretim
- Kasa içi dekoratif eloksallı alüminyum profil

OPSİYONEL

- Alüminyum & Ahşap kasa kaplama seçeneği

KANAT

- 1,2 mm x2 yekpare galvaniz çelik
- Çelik üzeri 8 mm masif dişbudak yüzey
- 42 densite poliüretan dolgu
- 14'lü kilit sistemi
- 6 adet sabit emniyet pimi
- Gizli emniyet kelepçesi
- 120 cm Krom yada alüminyum elektro statik boyalı kol
- Kanat etrafı dekoratif eloksallı alüminyum çıta
- Geniş açılı lüks dürbün
- Kaynaksız ayarlı menteşe
- Kanat Kalınlığı 100 mm

DOOR FRAME

- It is made from 2 mm galvanized steel
- Frame can be adjusted to 18 cm - 24 cm wall thickness
- Special manufacturing for over 24 cm
- inside frame has decorative eloxal aluminium profile

OPTIONAL

- Aluminium & Wooden frame coating can be done

DOOR LEAF

- It is made from 1,2 mm two monolith plates galvanized steel
- 8 mm natural wooden surface over front steel leaf
- Inside door leaf is filled by 42 density polyurethane
- 14 point central locking system
- 6 pieces stable safety pin
- Hidden safety clips
- Chromium or aluminium electro static painted door handle (120 cm)
- Luxury peephole
- Weldless adjustable hinges
- Around door leaf is designed by special anodized aluminium
- Leaf Thickness 100 mm

* Thermowood® Ürünü her iki yılda bir koruyucu olarak su bazlı vernik ile bakımı yapılır. Bu işlem ilk olarak fabrikamızda uygulanır.

* The product of Thermowood® is preserved every 2 years with a water based varnish as a preservative. This process is applied in our factory.

SERTİFİKALARIMIZ
CERTIFICATES



WOODEN

WDN 101

Wooden Serisi
Marin
Marine



KASA

- 2 mm galvaniz çelik
- 18 - 24 cm duvar kalınlığı
- 24 cm üzeri özel üretim
- Kasa içi dekoratif eloksallı alüminyum profil

OPSİYONEL

- Alüminyum & Ahşap kasa kaplama seçeneği

KANAT

- 1,2 mm x2 yekpare galvaniz çelik
- Çelik üzeri su kontrastı yüzey, krom ve cam detay
- 42 densite poliüretan dolgu
- 14'lü kilit sistemi
- 6 adet sabit emniyet pimi
- Gizli emniyet kelepçesi
- 120 cm Krom yada alüminyum kol
- Kanat etrafı dekoratif eloksallı alüminyum çita
- Geniş açılı lüks dürbün
- Kaynaksız ayarlı menteşe
- Kanat Kalınlığı 100 mm

DOOR FRAME

- It is made from 2 mm galvanized steel
- Frame can be adjusted to 18 cm - 24 cm wall thickness
- Special manufacturing for over 24 cm
- Inside frame has decorative eloxal aluminium profile

OPTIONAL

- Aluminium & Wooden frame coating can be done

DOOR LEAF

- It is made from 1,2 mm two monolith plates galvanized steel
- Water-contrast wooden surface over front steel leaf with chrome and glass detail.
- Inside door leaf is filled by 42 density polyurethane
- 14 point central locking system
- 6 pieces stable safety pin
- Hidden safety clips
- Chromium or aluminium door handle (120 cm)
- Luxury peephole
- Weldless adjustable hinges
- Around door leaf is designed by special anodized aluminium
- Leaf Thickness 100 mm



Kesit Görünüşü | Section View

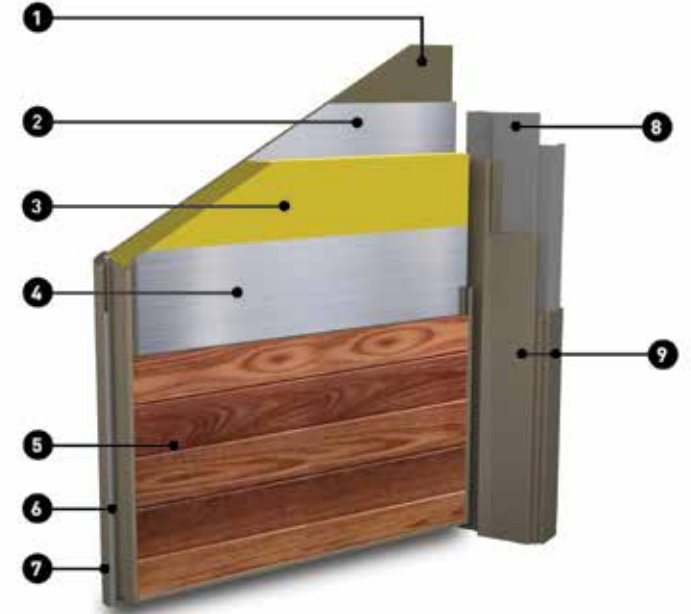

- | | | | |
|---|---|---|--|
| 1 | MDF Arka Yüzey
MDF Surface Above steel Over | 6 | İzolasyon Fıtılı
Insulation Gasket |
| 2 | 1,2 mm Yekpare Galvaniz Çelik
1,2 mm Solid Galvanized Steel | 7 | Kanat Etrafı: Elokosal Alüminyum Çita
Anodized Aluminum Profile Around the Door Leaf |
| 3 | 42 Densite Poliüretan Dolgu
42 Density Polyurethane Filler | 8 | 2 mm Galvaniz Çelik, Elektrostatik Toz Boya
2 mm Galvanized Steel Electrostatic Powder Paint |
| 4 | 1,2 mm Yekpare Galvaniz Çelik
1,2 mm Solid Galvanized Steel | 9 | Alüminyum Kasa Pervaz Kaplama
Aluminum Frame Trim |
| 5 | Özel Doğal Ahşap Yüzey
Special Natural Wood Surface | | |

SERTİFİKALARIMIZ
CERTIFICATES



Darbeğe Dayanır
40 Ton
Impact Resistant
40 Tonne



Eğilmeye Dayanır
5 Ton
Flexure Endurance
5 Tonne



Dayanıklı Ön Zeh
Double Front Armor



Ayarlı Menteşe
Adjustable Hinge



Çevre Dostu
Eco-Friendly



Çiğirmeye Karşı
Dayanıklı Yüzey
Surface Resistance
To Scratching



E60, EI+4S
E60 - EI+4S



Neme Dayanıklıdır
Resistant To Moisture



Ses İzolasyonu
Sağlayan Özel Yapı
Special Structure That
Provides Sound Insulation



Isı İzolasyonu
Sağlayan Özel Yapı
Special Structure
Provides Heat
Resistance Isolation



Rüzgara Dayanıklı
Resistance to wind load

DELUX GLASS



DLX 100

DELUX Serisi
Ultra
Ultra

KASA

- 2 mm galvaniz çelik
- 18 - 24 cm duvar kalınlığı
- 24 cm ve üzeri özel ölçü
- Kasa içi dekoratif eloksallı alüminyum profil

OPSİYONEL

- Alüminyum & Ahşap kasa kaplama seçeneği

KANAT

- 1,2 mm X 2 yekpare galvaniz çelik
- Kanadın her iki tarafında çelik üzeri 6 mm temperli dekoratif cam yüzey / 42 densite poliüretan dolgu
- Merkezi 14'lü kilit sistemi / 6 adet sabit emniyet pimi
- Gizli emniyet kelepçesi / 120 cm Krom yada alüminyum çekme kol
- Kanat etrafı dekoratif eloksallı alüminyum çita
- Kaynaksız ayarlı menteşe
- Kanat Kalınlığı 100 mm

DOOR FRAME

- It is made from 2 mm galvanized steel
- Frame can be adjusted to 18 cm - 24 cm wall thickness
- Special manufacturing for over 24 cm
- Inside frame has decorative eloxal aluminium profile

OPTIONAL

- Aluminium & Wooden frame coating can be done

DOOR LEAF

- It is made from 1,2 mm two monolith plates galvanized steel
- Decorative fitted 6 mm tempered glass surface on both side of steel leaf
- Inside door leaf is filled by 42 density polyurethane
- 14 point central locking system / 6 pieces stable safety pin
- Hidden safety clips / 120 cm Chromium or aluminium door handle
- Weldless adjustable hinges
- Around door leaf is designed by special anodized aluminium
- Leaf Thickness 100 mm

Cam Tipi | Glass Type



TPE
Tarafından
Patentlenmiştir



- 1 2 mm Montaj Kasası
2 mm Mounting Frame
- 2 6 mm Temperli Cam
6 mm Tempered Glass Surface
- 3 Kanat Etrafı Özel Elokmalı Alüminyum Çita
Around Door Leaf is Designed by Special Anodized Aluminium
- 4 Işık Geçirgen Temperli Isı Cam
Light Permeable Tempered Glass
- 5 Işık Penceresi
Light Window
- 6 Özel İzolasyon Filtiri
Special Insulation Wick
- 7 Özel Paslanmaz Çekme Kolu
Special Stainless Pull Handle
- 8 1,2 mm Yekpare Galvaniz Çelik
1,2 mm Monolith Plates Galvanized Steel

- 9 42 Densite Poliüretan Dolgu
Filled by 42 Density Polyurethane
- 10 Paslanmaz Krom Oluşturulmuş Çerçeve Detayı
Stainless Chrome Formed Frame Detail
- 11 Dayanıklı Ön Zırh
Durable Front Armor
- 12 Boya ile Oluşturulmuş Fuga Detayı
Generated With Paint Fuga Detail
- 13 Yavru Kanat Bağlantı Direği (Alüminyum)
Small Leaf Connection Post (Aluminium)
- 14 Alüminyum Çerçeve
Aluminium frame

SERTİFİKALARIMIZ
CERTIFICATES



DELUX GLASS

DLX 101
DELUX Serisi
Milenyum
Millennium

KASA

- 2 mm galvaniz çelik
- 18 - 24 cm duvar kalınlığı
- 24 cm ve üzeri özel ölçü
- Kasa içi dekoratif eloksallı alüminyum profil

OPSİYONEL

- Alüminyum & Ahşap kasa kaplama seçeneği

KANAT

- 1,2 mm X 2 yeypare galvaniz çelik
- Kanadın her iki tarafında çelik üzeri 6 mm temperli dekoratif cam yüzey / 42 densite poliüretan dolgu
- Merkezi 14'lü kilit sistemi / 6 adet sabit emniyet pimi
- Gizli emniyet kelepçesi / Krom çekme kol
- Kanat etrafı dekoratif eloksallı alüminyum çıta
- Kaynaksız ayarlı menteşe
- Kanat Kalınlığı 100 mm

DOOR FRAME

- It is made from 2 mm galvanized steel
- Frame can be adjusted to 18 cm - 24 cm wall thickness
- Special manufacturing for over 24 cm
- Inside frame has decorative eloxal aluminium profile

OPTIONAL

- Aluminium & Wooden frame coating can be done

DOOR LEAF

- It is made from 1,2 mm two monolith plates galvanized steel
- Decorative fitted 6 mm tempered glass surface on both side of steel leaf
- Inside door leaf is filled by 42 density polyurethane
- 14 point central locking system / 6 pieces stable safety pin
- Hidden safety clips / Chromium door handle
- Weldless adjustable hinges
- Around door leaf is designed by special anodized aluminium
- Leaf Thickness 100 mm

Cam Tipi | Glass Type



TPE
Tarafından
Patentlenmiştir



- 1 İzolasyon Fittili
Insulation Wick
- 2 Kanat Etrafı Alüminyum Çerçeve
Aluminium Frame Around Leaf
- 3 Işık Geçirgen Temperli Isı Cam
Light Permeable Tempered Glass
- 4 Boya ile Oluşturulmuş Çerçeve Detayı
Generated With Paint Window Frame Detail
- 5 6 mm Temperli Cam
6 mm Tempered Glass Surface
- 6 Yavru Kanat Bağlantı Direği (Alüminyum)
Small Leaf Connection Post (Aluminium)
- 7 Boya ile Oluşturulmuş Çerçeve Detayı
Generated With Paint Window Frame Detail
- 8 1,2 mm Yeypare Galvaniz Çelik
1,2 mm Monolith Plates Galvanized Steel
- 9 42 Densite Poliüretan Dolgu
Filled by 42 Density Polyurethane
- 10 Dayanıklı Ön Zırh
Durable Front Armor
- 11 6 mm Temperli Cam
6 mm Tempered Glass Surface
- 12 Alüminyum Kasa Kaplama *(OPSİYONEL)
Aluminium Case Coating *(OPTIONAL)
- 13 2 mm Montaj Kasası
2 mm Mounting Frame
- 14 Özel Paslanmaz Çekme Kolu
Special Stainless Pull Handle

SERTİFİKALARIMIZ
CERTIFICATES



GLASS



GLS 101

Glass Serisi
Piano Milano Ceviz
Piano Milano Walnut



KASA

- 2 mm galvaniz çelik - 18 ve 24 cm duvar kalınlığı - 24 cm ve üzeri özel ölçü
- Kasa içi dekoratif eloksallı alüminyum profil

OPSİYONEL

- Alüminyum & Ahşap kasa kaplama seçeneği

KANAT

- 1,2 mm X 2 yekpare galvaniz çelik - Özel fugalı cam yüzey - Kapı orta kısmı extra 1 mm çelik PVC kaplamalı dekoratif panel - 42 densite poliüretan dolgu - Merkezi 14'lü kilit sistemi - 6 adet sabit emniyet pimi - Gizli emniyet kelepçesi - Krom yada alüminyum kare kol - Kanat etrafı dekoratif eloksallı alüminyum çita - Geniş açılı lüks dürbün - Kaynaksız ayarlı menteşe - Kanat Kalınlığı 100 mm

DOOR FRAME

- It is made from 2 mm galvanized steel - Frame can be adjusted to 18 cm - 24 cm wall thickness - Special manufacturing for over 24 cm
- Inside frame has decorative eloxal aluminium profile

OPTIONAL

Aluminium & Wooden frame coating can be done

DOOR LEAF

- It is made from 1,2 mm two monolith plates galvanized steel
- Special fuga designed fitted glass surface over front steel leaf middle part of door has extra 1 mm steel PVC lamination decorative pannel - Inside door leaf is filled by 42 density polyurethane - 14 point central locking system - 6 pieces stable safety pins - Hidden safety clips
- Chromium or aluminium quadratic door handle - Luxury peephole
- Weldless adjustable hinges - Around door leaf is designed by special anodized aluminium
- Leaf Thickness 100 mm

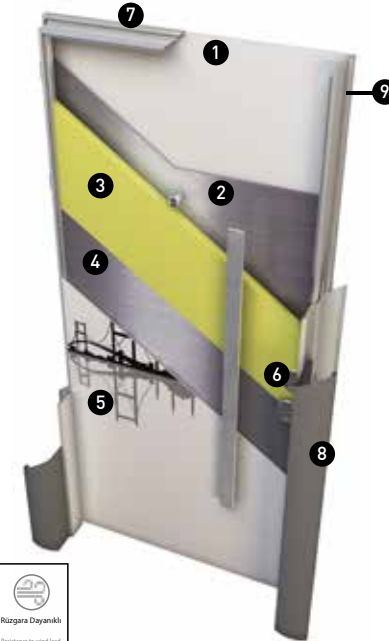

- 1 İç Taraf MDF Yüzey
Inside MDF Surface
- 2 1,2 mm Yekpare Galvaniz Çelik
1,2 mm Monolith Plates Galvanized Steel
- 3 42 Densite Poliüretan Dolgu
Filled by with Density Polyurethane
- 4 1,2 mm Yekpare Galvaniz Çelik
1,2 mm Monolith Plates Galvanized Steel
- 5 6 mm Temperli Cam Yüzey
6 mm Tempered Glass Surface
- 6 14'lü Kilit Sistemi
14 Point Lock System
- 7 Kanat Etrafı Özel Elokallı Alüminyum Çita
Around Door Leaf is Designed by Special Anodized Aluminium
- 8 Çelik üzeri özel laminasyonlu PVC kaplama Kasa geçme
Special laminated PVC coating on steel
- 9 Kanat Etrafı İzolasyon Filtiri
Leaf Insulation Roving Around
- 10 Lüks Gözetleme Dürbünü
Luxury Surveillance Binoculars

SERTİFİKALARIMIZ
CERTIFICATES



GLASS

GLS 107

Glass Serisi
Cross Bronz
Cross Bronze



Diş Cephe İçin Uygundur
Güneşe Dayanır
Suitable for Exterior Facade

KASA

- 2 mm galvaniz çelik
- 18 - 24 cm duvar kalınlığı
- 24 cm ve üzeri özel ölçü
- Kasa içi dekoratif eloksallı alüminyum profil

OPSİYONEL

- Alüminyum & Ahşap kasa kaplama seçeneği

KANAT

- 1,2 mm X 2 yekpare galvaniz çelik
- Çelik üzeri 6 mm temperli dekoratif cam yüzey
- 42 densite poliüretan dolgu
- Merkezi 14'lü kilit sistemi
- 6 adet sabit emniyet pimi
- Gizli emniyet kelepçesi
- 120 cm Krom yada alüminyum kare kol
- Kanat etrafı dekoratif eloksallı alüminyum çıta
- Geniş açılı lüks dürbün
- Kaynaksız ayarlı menteşe
- Kanat Kalınlığı 100 mm

DOOR FRAME

- It is made from 2 mm galvanized steel
- Frame can be adjusted to 18 cm - 24 cm wall thickness
- Special manufacturing for over 24 cm
- Inside frame has decorative eloxal aluminium profile

OPTIONAL

Aluminium & Wooden frame coating can be done

DOOR LEAF

- It is made from 1,2 mm two monolith plates galvanized steel
- Decorative designed 6mm tempered glass fitted surface over front steel leaf
- Inside door leaf is filled by 42 density polyurethane
- 14 point central locking system
- 6 pieces stable safety pin
- Hidden safety clips
- Chromium or aluminium quadric 120 cm door handle
- Luxury peephole
- Weldless adjustable hinges
- Around door leaf is designed by special anodized aluminium
- Leaf Thickness 100 mm



SERTİFİKALARIMIZ
CERTIFICATES



GLASS

GLS 110

Glass Serisi
Glass Semi Antrasit Beyaz
Glass Semi Anthracite White

KASA

- 2 mm galvaniz çelik
- 18 - 24 cm duvar kalınlığı
- 24 cm ve üzeri özel ölçü
- Kasa içi dekoratif eloksallı alüminyum profil

OPSİYONEL

- Alüminyum & Ahşap kasa kaplama seçeneği

KANAT

- 1,2 mm X 2 yekpare galvaniz çelik
- Çelik üzeri 6 mm temperli dekoratif cam yüzey ve ahşap detay
- 42 densite poliüretan dolgu
- Merkezi 14'lü kilitleme sistemi
- 6 adet sabit emniyet pimi
- Gizli emniyet kelepçesi
- 120 cm krom yada alüminyum kare kol
- Kanat etrafı dekoratif eloksallı alüminyum çıta
- Geniş açılı lüks dürbün
- Kaynaksız ayarlı menteşe
- Kanat Kalınlığı 100 mm

DOOR FRAME

- It is made from 2 mm galvanized steel
- Frame can be adjusted to 18 cm - 24 cm wall thickness
- Special manufacturing for over 24 cm
- Inside frame has decorative eloxal aluminium profile

OPTIONAL

- Aluminium & Wooden frame coating can be done

DOOR LEAF

- It is made from 1,2 mm two monolith plates galvanized steel
- Decorative fitted 6 mm tempered glass surface and wooden detail over front steel leaf
- Inside door leaf is filling by 42 density polyurethane
- 14 point central locking system
- 6 pieces stable safety pin
- Hidden safety clips
- Chromium or aluminium quadratic 120 cm door handle
- Luxury peephole
- Weldless adjustable hinges
- Around door leaf is designed by special anodized aluminium
- Leaf Thickness 100 mm



SERTİFİKALARIMIZ
CERTIFICATES



Darbeye Dayanır
40 Ton
Impact Resistant
40 Tonne



Eğilmeyi Dayanır
5 Ton
Resists Bending
5 Tonne



Dayanıklı Ön Zeh
Durable Front Armor



Ayarlı Menteşe
Adjustable Hinge



Çevre Dostu
Eco-Friendly



Çiğilmeye Karşı
Dayanıklı Yüzey
Scratch Resistant
Surface



E60, E64S
E60 - E64S



Neme Dayanıklıdır
Resistant to Moisture



Ses İzolasyonu
Sağlayan Özel Yapı
Special Structure That
Provides Sound Insulation



İzo İzolasyonu
Sağlayan Özel Yapı
Special Structure
That Provides Heat
Resistance Isolation



Rüzgara Dayanıklı
Resistance to wind load

GLASS

GLS 104

Glass Serisi
İstanbul Cam Beyaz
İstanbul White Glass

KASA

- 2 mm galvaniz çelik
- 18 - 24 cm duvar kalınlığı
- 24 cm ve üzeri özel ölçü
- Kasa içi dekoratif eloksallı alüminyum profil

OPSİYONEL

- Alüminyum & Ahşap kasa kaplama seçeneği

KANAT

- 1,2 mm X 2 yekpare galvaniz çelik
- Çelik üzeri 6 mm temperli dekoratif cam yüzey
- 42 densite poliüretan dolgu
- Merkezi 14'lü kilit sistemi
- 6 adet sabit emniyet pimi
- Gizli emniyet kelepçesi
- 120 cm Krom yada alüminyum çekme kolu
- Kanat etrafı dekoratif eloksallı alüminyum çita
- Geniş açılı lüks dürbün
- Kaynaksız ayarlı menteşe
- Kanat Kalınlığı 100 mm

DOOR FRAME

- It is made from 2 mm galvanized steel
- Frame can be adjusted to 18 cm - 24 cm wall thickness
- Special manufacturing for over 24 cm
- Inside frame has decorative eloxal aluminium profile

OPTIONAL

- Aluminium & Wooden frame coating can be done

DOOR LEAF

- It is made from 1,2 mm two monolith plates galvanized steel
- Decorative fitted 6 mm tempered glass surface over front steel leaf
- Inside door leaf is filled by 42 density polyurethane
- 14 point central locking system
- 6 pieces stable safety pin
- Hidden safety clips
- Chromium or aluminium door handle
- Luxury peephole
- Weldless adjustable hinges
- Around door leaf is designed by special anodized aluminium
- Leaf Thickness 100 mm



GLS 108

Glass Serisi
Eva Açık Ceviz - Beyaz
Eva Light Walnut - White

KASA

- 2 mm galvaniz çelik
- 18 - 24 cm duvar kalınlığı
- 24 cm ve üzeri özel ölçü
- Kasa içi dekoratif eloksallı alüminyum profil

OPSİYONEL

- Alüminyum & Ahşap kasa kaplama seçeneği

KANAT

- 1,2 mm X 2 yekpare galvaniz çelik
- Çelik üzeri 6 mm temperli dekoratif cam yüzey ve ahşap detay
- 42 densite poliüretan dolgu
- Merkezi 14'lü kilit sistemi
- 6 adet sabit emniyet pimi
- Gizli emniyet kelepçesi
- 120 cm Krom yada alüminyum kare kol
- Kanat etrafı dekoratif eloksallı alüminyum çita
- Geniş açılı lüks dürbün
- Kaynaksız ayarlı menteşe
- Kanat Kalınlığı 100 mm

DOOR FRAME

- It is made from 2 mm galvanized steel
- Frame can be adjusted to 18 cm - 24 cm wall thickness
- Special manufacturing for over 24 cm
- Inside frame has decorative eloxal aluminium profile

OPTIONAL

- Aluminium & Wooden frame coating can be done

DOOR LEAF

- It is made from 1,2 mm two monolith plates galvanized steel
- Decorative fitted 6 mm tempered glass surface and wooden detail over front steel leaf
- Inside door leaf is filling by 42 density polyurethane
- 14 point central locking system
- 6 pieces stable safety pin
- Hidden safety clips
- Chromium or aluminium quadratic 120 cm door handle
- Luxury peephole
- Weldless adjustable hinges
- Around door leaf is designed by special anodized aluminium
- Leaf Thickness 100 mm



GLS 109

Glass Serisi
Eva Beyaz - Amerikan Ceviz / Eva White - Amerikan Walnut

SERTİFİKALARIMIZ
CERTIFICATES



Darbeye Dayanır
40 Ton
Impact Resistant
40 Tonne



Eğilmeye Dayanır
5 Ton
Flexure Endurance
5 Tonne



Dayanıklı Ön Zeh
Double Front Armor



Ayarlı Menteşe
Adjustable Hinge



Çevre Dostu
Eco-Friendly



Çizilmeye Karşı
Dayanıklı Yüzey
Surface Resistance
to Scratching



E60, E4+5
E60 - E4+5



Nemeye Dayanıklıdır
Resistant to Moisture



Ses İzolasyonu
Sağlayan Özel Yapı
Special Structure that
Provides Sound Insulation



Isı İzolasyonu
Sağlayan Özel Yapı
Special Structure
Provides Heat
Resistance Isolation



Rüzgarına Dayanıklı
Resistance to wind load

NEOCLASSIC GLASS



NCG 103

Neoclassic Glass Seri

Roma Glass Antrasit

Roma Glass Anthracite



KASA

- 2 mm galvaniz çelik
- 18 - 24 cm duvar kalınlığı
- 24 cm ve üzeri özel ölçü
- Kasa içi dekoratif eloksallı alüminyum profil

OPSIYONEL

- Alüminyum & Ahşap kasa kaplama seçeneği

KANAT

- 1,2 mm X 2 yekpare galvaniz çelik
- Çelik üzeri dış cepheye dayanıklı özel fiber yüzey
- 42 densite poliüretan dolgu
- 14'lü merkezi kilit sistemi
- 6 adet sabit emniyet pimi
- Gizli emniyet kelepçesi
- Özel çekme kol
- Kanat etrafı dekoratif eloksallı alüminyum çita
- Kaynaksız ayarlı menteşe
- Kanat Kalınlığı: 100 mm

DOOR FRAME

- It is made from 2 mm galvanized steel
- Frame can be adjusted to 18 cm - 24 cm wall thickness
- Special manufacturing for over 24 cm
- Inside frame has decorative eloxal aluminium profile

OPTIONAL

- Aluminium & Wooden frame coating can be done

DOOR LEAF

- It is made from 1,2 mm two monolith plates galvanized steel
- Special fiber surface resistant to external front over steel
- Inside door leaf is filling by 42 density polyurethane
- 14 point central locking system
- 6 pieces stable safety pin
- Hidden safety clips
- Special Chromium door handle
- Weldless adjustable hinges
- Around door leaf is designed by special anodized aluminium
- Leaf Thickness 100 mm

SERTİFİKALARIMIZ
CERTIFICATES



NEOCLASSIC GLASS



NCG 104
Neoclassic Glass Seri
Roma Glass Beyaz
RomaGlass White



- 1 Alüminyum kasa pervaz kaplama
Aluminum Frame Trim
- 2 Alüminyum orta, kasa pervaz kaplama
Aluminum Center Frame Cover,
- 3 2 mm galvaniz çelik, elektrostatik toz boya
2 mm galvanized steel electrostatic powder paint
- 4 Alüminyum iç kasa
Aluminum inner case,
- 5 Fiberglass yüzey
Fiber glass surface
- 6 1,2 mm yekpare galvaniz çelik
1,2 mm solid galvanized steel
- 7 42 Densite poliüretan dolgu
42 Density polyurethane filler
- 8 1,2 milimetre yekpare galvaniz çelik
1,2 mm Solid galvanized steel
- 9 Fiberglass yüzey
Fiber glass surface
- 10 İzolasyon fitili
Insulation Gasket
- 11 Kanat etrafı eloksal alüminyum çita
Anodized Aluminum Profile Around the Door Leaf



NCG 104 Double
Neoclassic Seri
Roma Glass RAL 8017 Ceviz
Roma Glass RAL 8017 Walnut



SERTİFİKALARIMIZ
CERTIFICATES



NEOCLASSIC



NCS 101

Neoclassic Seri
Napoli Antrasit
Napoli Anthracite



KASA

- 2 mm galvaniz çelik
- 18 - 24 cm duvar kalınlığı
- 24 cm ve üzeri özel ölçü
- Kasa içi dekoratif eloksallı alüminyum profil

OPSİYONEL

- Alüminyum & Ahşap kasa kaplama seçeneği

KANAT

- 1,2 mm X 2 yekpare galvaniz çelik
- Çelik üzeri dış cepheye dayanıklı özel fiber yüzey
- 42 densite poliüretan dolgu
- 14'lü merkezi kilit sistemi
- 6 adet sabit emniyet pimi
- Gizli emniyet kelepçesi
- Özel krom çekme kol
- Kanat etrafı dekoratif eloksallı alüminyum çita
- Geniş açılı lüks dürbün
- Kaynaksız ayarlı menteşe
- Kanat Kalınlığı 100 mm

DOOR FRAME

- It is made from 2 mm galvanized steel
- Frame can be adjusted to 18 cm - 24 cm wall thickness
- Special manufacturing for over 24 cm
- Inside frame has decorative eloxal aluminium profile

OPTIONAL

- Aluminium & Wooden frame coating can be done

DOOR LEAF

- It is made from 1,2 mm two monolith plates galvanized steel
- Special fiber surface above steel suitable for exterior
- Inside door leaf is filling by 42 density polyurethane
- 14 point central locking system
- 6 pieces stable safety pin
- Hidden safety clips
- Special chromium door handle
- Luxury peephole
- Weldless adjustable hinges
- Around door leaf is designed by special anodized aluminium
- Leaf Thickness 100 mm

Renk Seçenekleri / Colour Options



Siyah
Black
RAL 9005

Antrasit Gri
Anthracite Grey
RAL 7016



Beyaz
White
RAL 9010

Ceviz
Walnut
RAL 8017

Kırmızı
Red
RAL 3020

SERTİFİKALARIMIZ
CERTIFICATES



NEOCLASSIC



NCS 102
Neoclassic Seri
Floransa Siyah
Floransa Black



Dış Cephe İçin Uygundur
Suitable for Exterior Facade



Renk Seçenekleri / Colour Options



Siyah
Black
RAL 9005



Antrasit Gri
Anthracite Grey
RAL 7016

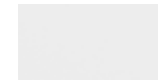

Beyaz
White
RAL 9010



Ceviz
Walnut
RAL 8017



Kırmızı
Red
RAL 3020

SERTİFİKALARIMIZ
CERTIFICATES



NEOCLASSIC



NCS 101

Neoclassic Seri
Napoli Beyaz
Napoli White



KASA

- 2 mm galvaniz çelik
- 18 - 24 cm duvar kalınlığı
- 24 cm ve üzeri özel ölçü
- Kasa içi dekoratif eloksallı alüminyum profil

OPSİYONEL

- Alüminyum & Ahşap kasa kaplama seçeneği

KANAT

- 1,2 mm X 2 yekpare galvaniz çelik
- Çelik üzeri dış cepheye dayanıklı özel fiber yüzey
- 42 densite poliüretan dolgu
- 14'lü merkezi kilit sistemi
- 6 adet sabit emniyet pimi
- Gizli emniyet kelepçesi
- Özel krom çekme kol
- Kanat etrafı dekoratif eloksallı alüminyum çita
- Kaynaksız ayarlı menteşe
- Kanat Kalınlığı 100 mm

DOOR FRAME

- It is made from 2 mm galvanized steel
- Frame can be adjusted to 18 cm - 24 cm wall thickness
- Special manufacturing for over 24 cm
- Inside frame has decorative eloxal aluminium profile

OPTIONAL

- Aluminium & Wooden frame coating can be done

DOOR LEAF

- It is made from 1,2 mm two monolith plates galvanized steel
- Special fiber surface above steel suitable for exterior
- Inside door leaf is filling by 42 density polyurethane
- 14 point central locking system
- 6 pieces stable safety pin
- Hidden safety clips
- Special Chromium door handle
- Weldless adjustable hinges
- Around door leaf is designed by special anodized aluminium
- Leaf Thickness 100 mm

Renk Seçenekleri / Colour Options



Siyah
Black
RAL 9005



Antrasit Gri
Anthracite Grey
RAL 7016

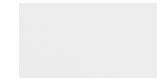

Beyaz
White
RAL 9010



Ceviz
Walnut
RAL 8017



Kırmızı
Red
RAL 3020

SERTİFİKALARIMIZ
CERTIFICATES



NEOCLASSIC

Roma 103 Neoclassic Seri Roma Beyaz Roma White



Roma 103 Neoclassic Seri Roma Ceviz Roma Walnut

KASA

- 2 mm galvaniz çelik
- 18 - 24 cm duvar kalınlığı
- 24 cm ve üzeri özel ölçü
- Kasa içi dekoratif eloksallı alüminyum profil

OPSİYONEL

- Alüminyum & Ahşap kasa kaplama seçeneği

KANAT

- 1,2 mm X 2 yeğpare galvaniz çelik	- Özel krom çekme kol
- Çelik üzeri dış cepheye dayanıklı özel fiber yüzey	- Kanat etrafı dekoratif eloksallı alüminyum çıta
- 42 densite poliüretan dolgu	- Geniş açılı lüks dürbün
- 14'lü merkezi kilitleme sistemi	- Kaynaksız ayarlı menteşe
- 6 adet sabit emniyet pimi	- Kanat Kalınlığı 100 mm
- Gizli emniyet kelepçesi	

DOOR FRAME

- It is made from 2 mm galvanized steel
- Frame can be adjusted to 18 cm - 24 cm wall thickness
- Special manufacturing for over 24 cm
- Inside frame has decorative eloxal aluminium profile

OPTIONAL

Aluminium & Wooden frame coating can be done

DOOR LEAF

- It is made from 1,2 mm two monolith plates galvanized steel
- Special fiber surface above steel suitable for exterior
- Inside door leaf is filling by 42 density polyurethane
- 14 point central locking system
- 6 pieces stable safety pin
- Hidden safety clips
- Special chromium door handle
- Luxury peephole
- Weldless adjustable hinges
- Around door leaf is designed by special anodized aluminium
- Leaf Thickness 100 mm

Renk Seçenekleri / Colour Options



Siyah
Black
RAL 9005



Antrasit Gri
Anthracite Grey
RAL 7016

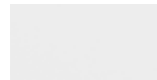

Beyaz
White
RAL 9010



Ceviz
Walnut
RAL 8017



Kırmızı
Red
RAL 3020

SERTİFİKALARIMIZ
CERTIFICATES



NEOCLASSIC



NCS 105

Neoclassic Seri
Britanya Kırmızı
Britania Red



Dış Cephe İçin Uygundur
Güneşe Dayanır
Suitable for Exterior Facade

KASA

- 2 mm galvaniz çelik
- 18 - 24 cm duvar kalınlığı
- 24 cm ve üzeri özel ölçü
- Kasa içi dekoratif eloksallı alüminyum profil

OPSİYONEL

- Alüminyum & Ahşap kasa kaplama seçeneği

KANAT

- 1,2 mm X 2 yekpare galvaniz çelik
- Çelik üzeri dış cepheye dayanıklı özel fiber yüzey
- 42 densite poliüretan dolgu
- 14'lü merkezi kilit sistemi
- 6 adet sabit emniyet pimi
- Gizli emniyet kelepçesi
- Özel krom çekme kol
- Kanat etrafı dekoratif eloksallı alüminyum çita
- Kaynaksız ayarlı menteşe
- Kanat Kalınlığı 100 mm

DOOR FRAME

- It is made from 2 mm galvanized steel
- Frame can be adjusted to 18 cm - 24 cm wall thickness
- Special manufacturing for over 24 cm
- Inside frame has decorative eloxal aluminium profile

OPTIONAL

- Aluminium & Wooden frame coating can be done

DOOR LEAF

- It is made from 1,2 mm two monolith plates galvanized steel
- Special fiber surface above steel suitable for exterior
- Inside door leaf is filling by 42 density polyurethane
- 14 point central locking system
- 6 pieces stable safety pin
- Hidden safety clips
- Special Chromium door handle
- Weldless adjustable hinges
- Around door leaf is designed by special anodized aluminium
- Leaf Thickness 100 mm

Özel kanat boyu - Min:101x206 | Max:110x240
Special leaf size - Min:101x206 | Max:110x240

NCS 106

Neoclassic Seri
Gölyaka
Lakeside



Dış Cephe İçin Uygundur
Güneşe Dayanır
Suitable for Exterior Facade



Özel kanat boyu - Min:96x218 | Max:100x240
Special leaf size - Min:96x218 | Max:100x240

Renk Seçenekleri / Colour Options

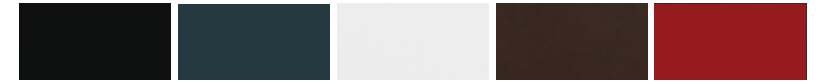

Siyah
Black
RAL 9005

Antrasit Gri
Anthracite Grey
RAL 7016

Beyaz
White
RAL 9010

Ceviz
Walnut
RAL 8017

Kırmızı
Red
RAL 3020

SERTİFİKALARIMIZ
CERTIFICATES



NEOCLASSIC



Roma 103 Double Neoclassic Seri Roma Beyaz Roma White



KASA

- 2 mm galvaniz çelik
- 18 - 24 cm duvar kalınlığı
- 24 cm ve üzeri özel ölçü
- Kasa içi dekoratif eloksallı alüminyum profil

OPSİYONEL

- Alüminyum & Ahşap kasa kaplama seçeneği

KANAT

- 1,2 mm X 2 yekpare galvaniz çelik
- Çelik üzeri dış cepheye dayanıklı özel fiber yüzey
- 42 densite poliüretan dolgu
- 14'lü merkezi kilit sistemi
- 6 adet sabit emniyet pimi
- Gizli emniyet kelepçesi
- Özel krom çekme kol
- Kanat etrafı dekoratif eloksallı alüminyum çita
- Kaynaksız ayarlı menteşe
- Kanat Kalınlığı 100 mm

DOOR FRAME

- It is made from 2 mm galvanized steel
- Frame can be adjusted to 18 cm - 24 cm wall thickness
- Special manufacturing for over 24 cm
- Inside frame has decorative eloxal aluminium profile

OPTIONAL

- Aluminium & Wooden frame coating can be done

DOOR LEAF

- It is made from 1,2 mm two monolith plates galvanized steel
- Special fiber surface above steel suitable for exterior
- Inside door leaf is filling by 42 density polyurethane
- 14 point central locking system
- 6 pieces stable safety pin
- Hidden safety clips
- Special Chromium door handle
- Weldless adjustable hinges
- Around door leaf is designed by special anodized aluminium
- Leaf Thickness 100 mm



DBL NCS 101 Neoclassic Seri

Antrasit Duble | Anthracite Double



Renk Seçenekleri / Colour Options



Siyah
Black



Antrasit Gri
Anthracite Grey

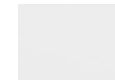

Beyaz
White



Ceviz
Walnut



Kırmızı
Red

SERTİFİKALARIMIZ
CERTIFICATES



ELEGANCE



ELG 113
Elegance Seri
Açık Emperador | Emperador Light

Kesit Görünüş | Section View

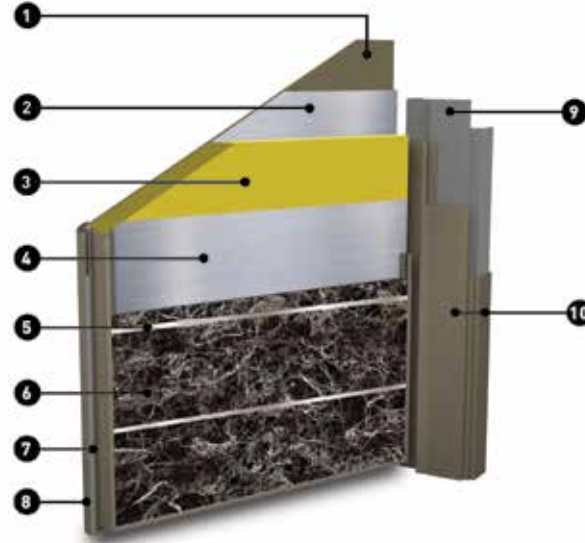

MDF Arka Yüze
MDF Surface Above steel Over

1,2 mm Yekpare Galvaniz Çelik
1,2 mm Solid Galvanized Steel

42 Densite Poliüretan Dolgu
42 Density Polyurethane Filler

1,2 mm Yekpare Galvaniz Çelik
1,2 mm Solid Galvanized Steel

Özel Doğal Ahşap Yüze
Special Natural Wood Surface

4 Alüminyum H Çita
Aluminium Joint Accessory

7 İzolasyon Filtisi
Insulation Gasket

8 Kanat Etrafı Eloksoal Alüminyum Çita
Anodized Aluminium Profile Around the Door Leaf

9 2 mm Galvaniz Çelik, Elektrostatik Toz Boya
2 mm Galvanized Steel Electrostatic Powder Paint

10 Alüminyum Kasa Pervaz Kaplama
Aluminium Frame Trim

ELG 126
Elegance Seri
Karera
Carrera



Elegance Seri

KASA
- 2 mm galvaniz çelik
- 18 - 24 cm duvar kalınlığı
- 24 cm ve üzeri özel ölçü
- Kasa içi dekoratif eloksallı alüminyum profil

OPSİYONEL
- Alüminyum & Ahşap kasa kaplama seçeneği

KANAT
- 1,2 mm X 2 yekpare galvaniz çelik
- Çelik üzeri dış cepheye dayanıklı özel waterproof yüze
- 42 densite poliüretan dolgu
- Merkezi 14'ü kilit sistemi
- 6 adet sabit emniyet pimi
- Gizli emniyet kelepçesi
- Krom yada alüminyum çekme kol
- Kanat etrafı dekoratif eloksallı alüminyum çita
- Geniş açılı lüks dürbün
- Kaynaksız ayarlı menteşe
- Kanat Kalınlığı 92 mm

ELG 108
Elegance Seri
Emperador Dark
Empredor Dark



DOOR FRAME

- It is made from 2 mm galvanized steel
- Frame can be adjusted to 18 cm - 24 cm wall thickness
- Special manufacturing for over 24 cm
- Inside frame has decorative eloxal aluminium profile

OPTIONAL

- Wooden or aluminium frame coating can be done

DOOR LEAF

- It is made from 1,2 mm two monolith plates galvanized steel
- Special waterproof surface resistant to external front over steel
- Inside door leaf is filling by 42 density polyurethane
- 14 point central locking system
- 6 pieces stable safety pin
- Hidden safety clips
- Chromium or aluminium door handle
- Luxury peephole
- Weldless adjustable hinges
- Around door leaf is designed by special anodized aluminium
- Leaf Thickness 92 mm

SERTİFİKALARIMIZ
CERTIFICATES



QUARTZ



QRZ 118

Quartz Serisi

Eva Açık Ceviz - Siyah

Eva Light Walnut - Black

KASA

- 2 mm galvaniz çelik
- 18 - 24 cm duvar kalınlığı
- 24 cm üzeri özel üretim
- Kasa içi dekoratif eloksallı alüminyum profil

OPSİYONEL

- Alüminyum & Ahşap kasa kaplama seçeneği

KANAT

- 1,2 mm x2 yekpare galvaniz çelik
- Çelik üzeri özel tasarım MDF ve Cam yüzey
- 42 densite poliüretan dolgu
- 14'lü kilitleme sistemi
- 6 adet sabit emniyet pimi
- Gizli emniyet kelepçesi
- 120 cm krom yada alüminyum çekme kolu
- Kanat etrafı dekoratif eloksallı alüminyum çıta
- Kanat Üzeri özel HG MDF yüzey
- Geniş açılı lüks dürbün
- Kaynaksız ayarlı menteşe
- Kanat Kalınlığı 100 mm

DOOR FRAME

- It is made from 2 mm galvanized steel
- Frame can be adjusted to
- 18 cm - 24 cm wall thickness
- Special manufacturing for over 24 cm
- Inside frame has decorative eloxal aluminium profile

OPTIONAL

- Aluminium & Wooden frame coating can be done

DOOR LEAF

- It is made from 1,2 mm two monolith plates galvanized steel
- Special modelling MDF fitted over front steel leaf
- Special HG laminated surface
- Inside door leaf is filled by 42 density polyurethane
- 14 point central locking system
- 6 pieces stable safety pin
- Hidden safety clips
- Chromium or aluminium door handle
- Luxury peephole
- Weldless adjustable hinges
- Around the door leaf is designed by special anodized aluminium
- Leaf Thickness 100 mm

SERTİFİKALARIMIZ
CERTIFICATES



Darbeye Dayanır
40 Ton
Impact Resistant
40 Tonne



Eğilmeye Dayanır
5 Ton
Flexure Endurance
5 Tonne



Dayanıklı Ön Zeh
Double Front Armor



Ayarlı Menteşe
Adjustable Hinge



Çevre Dostu
Eco-Friendly



Çizilmeye Karşı
Dayanıklı Yüzey
Surface Resistance
To Scratching



E60, EI+4S



Neme Dayanıklıdır
Resistant To Moisture



Ses İzolasyonu
Sağlayan Özel Yapı
Special Structure That
Provides Sound Insulation



Isı İzolasyonu
Sağlayan Özel Yapı
Special Structure
Provides Heat
Resistance Isolation



Rüzgara Dayanıklı
Resistance to wind load



QRZ 120
Quartz Serisi
Çamlica Antrasit Gri
Chamlica Anthracite Grey

- KASA**
- 2 mm galvaniz çelik
 - 18 - 24 cm duvar kalınlığı
 - 24 cm üzeri özel üretim
 - Kasa içi dekoratif eloksallı alüminyum profil

- OPSİYONEL**
- Alüminyum & Ahşap kasa kaplama seçeneği

- KANAT**
- 1,2 mm x2 yekpare galvaniz çelik
 - Çelik üzeri MDF yüzey
 - 42 densite poliüretan dolgu
 - Alüminyum dekoratif çita
 - 14'lü kilit sistemi
 - 6 adet sabit emniyet pimi
 - Gizli emniyet kelepçesi
 - 120 cm Krom yada alüminyum kol
 - Kanat etrafı dekoratif eloksallı alüminyum çita
 - Geniş açılı lüks dürbün
 - Kaynaksız ayarlı menteşe
 - Kanat Kalınlığı 100 mm

- DOOR FRAME**
- It is made from 2 mm galvanized steel
 - Frame can be adjusted to 18 cm - 24 cm wall thickness
 - Special manufacturing for over 24 cm
 - Inside frame has decorative eloxal aluminium profile

- OPTIONAL**
- Aluminium & Wooden frame coating can be done

- DOOR LEAF**
- It is made from 1,2 mm two monolith plates galvanized steel
 - Special MDF surface over steel leaf
 - Aluminum decorative lath
 - Inside door leaf is filled by 42 density polyurethane
 - 14 point central locking system
 - 6 pieces stable safety pin
 - Hidden safety clips
 - Chromium or aluminium door handle (120 cm)
 - Luxury peephole
 - Weldless adjustable hinges
 - Around the door leaf is designed by special anodized aluminium
 - Leaf Thickness 100 mm



QRZ 120 Double
Quartz Serisi
Çamlica Antrasit Gri
Chamlica Anthracite Grey

SERTİFİKALARIMIZ
CERTIFICATES



QUARTZ



QRZ 102
Quartz Serisi
Lines Beyaz
Lines White

QRZ 108
Quartz Serisi
Mostar Milano Ceviz - HG Beyaz
Mostar Milano Walnut - HG White



TPE
Tarafından
Patentlenmiştir

QRZ 103
Quartz Serisi
Mostar Milano Ceviz - HG Siyah
Mostar Milano Walnut - HG Black



KASA

- 2 mm galvaniz çelik
- 18 - 24 cm duvar kalınlığı
- 24 cm üzeri özel üretim
- Kasa içi dekoratif eloksallı alüminyum profil

OPSİYONEL

- Alüminyum & Ahşap kasa kaplama seçeneği

KANAT

- 1,2 mm x2 yekpare galvaniz çelik
- Çelik üzeri MDF yüzey
- 42 densite poliüretan dolgu
- Alüminyum dekoratif çıta
- 14'lü kilit sistemi
- 6 adet sabit emniyet pimi
- Gizli emniyet kelepçesi
- 120 cm Krom yada alüminyum kol
- Kanat etrafı dekoratif eloksallı alüminyum çıta
- Geniş açılı lüks dürbün
- Kaynaksız ayarlı menteşe
- Kanat Kalınlığı 100 mm

DOOR FRAME

- It is made from 2 mm galvanized steel
- Frame can be adjusted to 18 cm - 24 cm wall thickness
- Special manufacturing for over 24 cm
- Inside frame has decorative eloxal aluminium profile

OPTIONAL

- Aluminium & Wooden frame coating can be done

DOOR LEAF

- It is made from 1,2 mm two monolith plates galvanized steel
- Special MDF surface over steel leaf
- Aluminum decorative lath
- Inside door leaf is filled by 42 density polyurethane
- 14 point central locking system
- 6 pieces stable safety pin
- Hidden safety clips
- Chromium or aluminium door handle (120 cm)
- Luxury peephole
- Weldless adjustable hinges
- Around the door leaf is designed by special anodized aluminium
- Leaf Thickness 100 mm

SERTİFİKALARIMIZ
CERTIFICATES





QRZ 114
Quartz Serisi
Padişah 7016 Antrasit Gri
Sultan 7016 Anthracite Grey

KASA

- 2 mm galvaniz çelik
- 18 - 24 cm duvar kalınlığı
- 24 cm üzeri özel üretim
- Kasa içi dekoratif eloksallı alüminyum profil

OPSİYONEL

- Alüminyum & Ahşap kasa kaplama seçeneği

KANAT

- 1,2 mm x2 yekpare galvaniz çelik
- Çelik üzeri özel modellenmiş doğal kaplama MDF yüzey
- 42 densite poliüretan dolgu
- 14'lü kilit sistemi
- 6 adet sabit emniyet pimi
- Gizli emniyet kelepçesi
- Özel krom çekme kolu
- Kanat etrafı dekoratif eloksallı alüminyum çita
- Geniş açılı lüks dürbün
- Kaynaksız ayarlı menteşe
- Kanat Kalınlığı 100 mm

QRZ 113
Quartz Serisi
Hanedan Modern Ceviz
Dynasty Modern Walnut



QRZ 112
Quartz Serisi
Padişah Lake Beyaz PVC
Sultan White PVC



DOOR FRAME

- It is made from 2 mm galvanized steel
- Frame can be adjusted to 18 cm - 24 cm wall thickness
- Special manufacturing for over 24 cm
- Inside frame has decorative eloxal aluminium profile

OPTIONAL

- Aluminium & Wooden frame coating can be done

DOOR LEAF

- It is made from 1,2 mm two monolith plates galvanized steel
- Special embossed laminated wooden surface over front steel leaf
- Inside door leaf is filled by 42 density polyurethane
- 14 point central locking system
- 6 pieces stable safety pin
- Hidden safety clips
- Special chromium door handle
- Luxury peephole
- Weldless adjustable hinges
- Around door leaf is designed by special anodized aluminium
- Leaf Thickness 100 mm

ASYMMETRIC



FLZ 116
Asimetrik Seri
Semi - Edi
Semi - Edi

KASA

- 2 mm galvaniz çelik
- 18 - 24 cm duvar kalınlığı
- 24 cm üzeri özel üretim
- Kasa içi dekoratif eloksallı alüminyum profil

OPSİYONEL

Ahşap & Kompozit kasa kaplama seçeneği

KANAT

- 1,2 mm x 2 yekpare galvaniz çelik
- Çelik üzeri özel modellenli MDF yüzey
- 42 densite poliüretan dolgu
- Kanca kilit sistemi
- 3 adet sabit emniyet pimi
- Gizli emniyet kelepçesi
- Krom yada alüminyum kol
- Kanat etrafı dekoratif eloksallı alüminyum çita
- Geniş açılı lüks dürbün
- Kaynaksız ayarlı menteşe
- Kanat Kalınlığı 100 mm

DOOR FRAME

- It is made from 2 mm galvanized steel
- Frame can be adjusted to 18 cm - 24 cm wall thickness
- Special manufacturing for over 24 cm

OPTIONAL

- Composite & Wooden frame coating can be done

DOOR LEAF

- It is made from 1,2 mm two monolith plates galvanized steel
- Special modelling natural MDF coating over steel surface
- Inside door leaf is filled by 42 density polyurethane
- Hook locking system
- 3 pieces stable safety pin
- Hidden safety clips
- Chromium or aluminium door handle
- Luxury peephole
- Weldless adjustable hinges
- Inside frame has decorative eloxal aluminium profile
- Around the door leaf is designed by special anodized aluminium
- Leaf Thickness 100 mm

KASA

- 2 mm galvaniz çelik
- 18 - 24 cm duvar kalınlığı
- 24 cm üzeri özel üretim
- Kasa içi dekoratif eloksallı alüminyum profil

OPSİYONEL

Ahşap & Kompozit kasa kaplama seçeneği

KANAT

- 1,2 mm x 2 yekpare galvaniz çelik
- Çelik üzeri özel modellenli cam yüzey
- 42 densite poliüretan dolgu
- Kanca kilit sistemi
- 3 adet sabit emniyet pimi
- Gizli emniyet kelepçesi
- Krom yada alüminyum kol
- Kanat etrafı dekoratif eloksallı alüminyum çita
- Geniş açılı lüks dürbün
- Kaynaksız ayarlı menteşe
- Kanat Kalınlığı 100 mm

DOOR FRAME

- It is made from 2 mm galvanized steel
- Frame can be adjusted to 18 cm - 24 cm wall thickness
- Special manufacturing for over 24 cm

OPTIONAL

- Composite & Wooden frame coating can be done

DOOR LEAF

- It is made from 1,2 mm two monolith plates galvanized steel
- Special modelling natural glass coating over steel surface
- Inside door leaf is filled by 42 density polyurethane
- Hook locking system
- 3 pieces stable safety pin
- Hidden safety clips
- Chromium or aluminium door handle
- Luxury peephole
- Weldless adjustable hinges
- Inside frame has decorative eloxal aluminium profile
- Around the door leaf is designed by special anodized aluminium
- Leaf Thickness 100 mm hh



FLZ 118
Asimetrik Seri
Mostar - Cam
Mostar - Glass



FLZ 117
Asimetrik Seri
Semi Model
Semi Model



FLZ 119
Asimetrik Seri
Semi Cam
Semi Glass

SERTİFİKALARIMIZ
CERTIFICATES





TRM 102

Thermomax Serisi

Paris - Antrasit Gri | Paris - Anthracite Grey



Dış Cephe İçin Uygundur
Güneşe Dayanır
Yükseklikler İçin Uygundur

KASA

- 2 mm galvaniz çelik
- 18 - 24 cm duvar kalınlığı
- 24 cm ve üzeri özel ölçü
- Kasa içi dekoratif eloksallı alüminyum profil

OPSİYONEL

- Alüminyum & Ahsap kasa kaplama seçeneği

CAM

- 6+70+6 ısı geçiirgen cam.

KANAT

- 1,2 mm X 2 yekpare galvaniz çelik
- Çelik üzeri dış hava şartlarına uygun kompozit yüzey
- 42 densite poliüretan dolgu
- 14'lü merkezi kilit
- 6 adet sabit emniyet pimi
- Gizli emniyet kelepçesi
- Krom yada alüminyum çekme kol
- Kanat etrafı dekoratif eloksallı alüminyum çita
- Kaynaksız ayarlı menteşe
- Kanat Kalınlığı: 100 mm

DOOR FRAME

- It is made from 2 mm galvanized steel
- Frame can be adjusted to 18 cm - 24 cm wall thickness
- Special manufacturing for over 24 cm
- Inside frame has decorative eloxal aluminium profile

OPTIONAL

- Wooden or aluminium frame coating can be done

GLASS

- 6+70+6 Light permeable tempered glass

DOOR LEAF

- It is made from 1,2 mm two monolith plates galvanized steel
- Special composite surface resistant to external front over steel
- Inside door leaf is filled by 42 density polyurethane
- 14 point central locking system
- 6 pieces stable safety pin
- Hidden safety clips
- Chrome or aluminium door handle
- Weldless adjustable hinges
- Around door leaf is designed by special anodized aluminium
- Leaf Thickness 100 mm

THERMOMAX

TRM 101
Thermomax Seri
Paris - Beyaz | Paris - White



Dış Cephe İçin Uygundur
Güneşe Dayanır
Suitable for Exterior Facade



- 1** 1,2 mm X 2 Yekpare Galvaniz Çelik
It Is Made From 1,2 Mm Two Monolithic Plates Galvanized Steel
- 2** 42 Densite Poliüretan Dolgu
Inside Door Leaf Is Filled By 42 Density Polyurethane
- 3** Standart Elektrostatik Toz Boya
2 mm Galvaniz Çelik Kasa
It Is Made From 2 Mm Galvanized Steel With Elektrostatik Powder Paint
- 4** Çelik Üzeri Dış Hava Şartlarına Uygun Kompozit Yüzey
Suitable For Outdoor Weather Conditions On Steel Composite Surface
- 5** İzolasyon Fittili
Insulation Cord
- 6** Sabit Emniyet Pimi
Safety Pin
- 7** Dekoratif Alüminyum Detay
Decorative Aluminum Detail
- 8** Cam Üzeri Boya Detay
Paint On Glass Detail
- 9** Dayanıklı Ön Zırh
Datanized Front Armor
- 10** Alüminyum Çekme Kol
Aluminum Pull Handle
- 11** 6+52+6 Işık Geçirgen Cam
6 + 52 + 6 Translucent Glass
- 12** Cam Etrafı Dekoratif Alüminyum Çıta Detayı
Glass Around Decorative Aluminum Lath Detail
- 13** Kasa İçi Taşyünü Dolgu
Rock Wool Filling Inside The Frame
- 14** Kanat Etrafı Dekoratif Eloksallı Alüminyum Çıta
Around Door Leaf Is Designed By Special Anodized Aluminium

Kesit Görünüş Section view



Cam Tipi Glass Type



TRM 102
Thermomax Seri
Paris - Antrasit Gri | Paris - Anthracite Grey

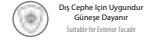

Dış Cephe İçin Uygundur
Güneşe Dayanır
Suitable for Exterior Facade



SERTİFİKALARIMIZ
CERTIFICATES



Darbeye Dayanır
40 Ton
Impact Resistant
40 Tonne



Eğilmeye Dayanır
5 Ton
Flexure Resistance
5 Tonne



Dayanıklı Ön Zırh
Durable Front Armor



Ayarlı Menteşe
Adjustable Hinge



Çevre Dostu
Eco-Friendly



Çalınmaya Karşı
Dayanıklı Yüzey
Surface Resistance
To Scratching



E60, E145
E60 - E145



Neme Dayanıklıdır
Resistant To Moisture



Ses İzolasyonu
Sağlayan Özel Yapı
Special Structure That
Provides Sound Insulation



Isı İzolasyonu
Sağlayan Özel Yapı
Special Structure
Resistant To Heat
Resistance Isolation



Rüzgara Dayanıklı
Resistance to wind load

PRESTIJ



PR 100
Prestij Serisi
Piano DB 93 / DB 20
Tik / Beyaz
Teak / White



KASA
- 2 mm galvaniz çelik
- 18 - 24 cm duvar kalınlığı
- 24 cm ve üzeri özel ölçü
- Standart elektrostatik toz boya

OPSİYONEL
- Alüminyum & Ahşap kasa kaplama seçeneği

KANAT
- 1,2 mm X 2 yekpare galvaniz çelik
- Çelik üzeri dış hava şartlarına uygun Kompozit yüzey
- 42 densite poliüretan dolgu
- Kanca kilit sistemi
- 3 adet sabit emniyet pimi
- Gizli emniyet kelepçesi
- Krom yada alüminyum çekme kol
- Kanat etrafı dekoratif eloksallı alüminyum çita
- Geniş açılı lüks dürbün
- Kaynaksız ayarlı menteşe
- Kanat Kalınlığı 92 mm

DOOR FRAME
- It is made from 2 mm galvanized steel
- Frame can be adjusted to 18 cm - 24 cm wall thickness
- Special manufacturing for over 24 cm
- Electrostatic powder paint

OPTIONAL
- Wooden or aluminium frame coating can be done

DOOR LEAF
- It is made from 1,2 mm two monolith plates galvanized steel
- Special composite surface resistant to external front over steel
- Inside door leaf is filling by 42 density polyurethane
- Hook locking system
- 3 pieces stable safety pin
- Hidden safety clips
- Chromium or aluminium door handle
- Luxury peephole
- Weldless adjustable hinges
- Around door leaf is designed by special anodized aluminium
- Leaf Thickness 92 mm

1,2 mm Yekpare Galvaniz Çelik
1,2 mm Monolith
Plates Galvanized Steel

42 Densite Poliüretan
Dolgu
Filled by 42 Density
Polyurethane

Kanca Kilit Sistemi
Hook Locking
System

1,2 mm Yekpare Galvaniz Çelik
1,2 mm Monolith Plates Galvanized
Steel

Dış Hava Şartlarına
Dayanıklı Özel
Kompozit yüzey

Outdoor Weather
Durable Customized
Surface

Kanat Etrafı Özel Elokallı
Alüminyum Çita

Around Door Leaf is Designed by
Special Anodized Aluminium



DB - 90
Koyu Abanoz
Dark Ebony



DB - 91
Açık Abanoz
Light Ebony



DB - 93
Antik Bambu
Antique Bamboo



DB - 94
İnce Ceviz
Nussbaum



DB - 98
Koyu Abanoz
Dark Ebony



DB - 99
Açık Abanoz
Light Ebony



DB - 86
Antik Bambu
Antique Bamboo



DB - 95
İnce Ceviz
Nussbaum

SERTİFİKALARIMIZ
CERTIFICATES



PRESTIJ

PR 113
Prestij Serisi
Zen DB 98 / DB Siyah
Zen Açık Abanoz / Siyah
Zen Light Ebony / Black



Dış Cephe İçin Uygundur
Güneşe Dayanır
Suitable for Exterior Facade

PR 111
Prestij Serisi
Semi DB 94 / DB13
Açık Altın Meşe / Grafit Gri
Light Gold Oak / Graphite Grey



Dış Cephe İçin Uygundur
Güneşe Dayanır
Suitable for Exterior Facade

PR 112
Prestij Serisi
Zen DB 90 / DB 13
Zen / Grafit Gri
Zen Fine Gold Oak / Graphite Grey



Dış Cephe İçin Uygundur
Güneşe Dayanır
Suitable for Exterior Facade

PR 110
Prestij Serisi
Semi DB 94 / DB 20
Açık Altın Meşe / Beyaz
Light GOLD Oak / White



Dış Cephe İçin Uygundur
Güneşe Dayanır
Suitable for Exterior Facade



SERTİFİKALARIMIZ
CERTIFICATES



Darbeye Dayanır
40 Ton
Impact Resistant
40 Tonne



Eğilmeyi Dayanır
5 Ton
Pressure Endurance
5 Tonne



Dayanıklı Ön Zeh
Durable Front Armor



Ayarlı Montaj
Adjustable Hinge



Çevre Dostu
Eco-Friendly



Çiğlemeye Karşı
Dayanıklı Yüzey
Surface Resistance
To Scratching



E60, E64S
600 - 6x45



Neme Dayanıklıdır
Resistant To Moisture



Ses İzolasyonu
Sağlayan Özel Yapı
Provides Sound Insulation



Hız İzolasyonu
Sağlayan Özel Yapı
Resistant to wind load



Rüzgar Dayanıklı
Resistance to wind load



PR 120 & 121

Prestij Serisi

Poem

DB 91 İnce Altın Meşe | Doğal Taş

DB 91 Light GOLD Oak | Naturel Rock



Dış Cephe İçin Uygundur
Güneşe Dayanır
Suitable for External Facade

KASA

- 2 mm galvaniz çelik
- 18 - 24 cm duvar kalınlığı
- 24 cm ve üzeri özel ölçü
- Standart elektrostatik toz boya

OPSİYONEL

- Alüminyum & Ahşap kasa kaplama seçeneği

KANAT

- 1,2 mm X 2 yekpare galvaniz çelik
- Çelik üzeri dış hava şartlarına uygun Kompozit yüzey ve doğal taş
- 42 densite poliüretan dolgu
- Kanca kilit sistemi
- 3 adet sabit emniyet pimi
- Gizli emniyet kelepçesi
- Krom yada alüminyum çekme kol
- Kanat etrafı dekoratif eloksallı alüminyum çıta
- Geniş açılı lüks dürbün
- Kaynaksız ayarlı menteşe
- Kanat Kalınlığı 92 mm

DOOR FRAME

- It is made from 2 mm galvanized steel
- Frame can be adjusted to 18 cm - 24 cm wall thickness
- Special manufacturing for over 24 cm
- Electrostatic powder paint

OPTIONAL

- Wooden or aluminium frame coating can be done

DOOR LEAF

- It is made from 1,2 mm two monolith plates galvanized steel
- Special composite and natural rock surface resistant to external front over steel
- Inside door leaf is filling by 42 density polyurethane
- Hook locking system
- 3 pieces stable safety pin
- Hidden safety clips
- Chromium or aluminium door handle
- Luxury peephole
- Weldless adjustable hinges
- Around door leaf is designed by special anodized aluminium
- Leaf Thickness 92 mm



PR 121

Prestij Serisi

Poem

DB 94 Açık Altın Meşe | Doğal Taş

DB 94 Kiefer Line Wood | Naturel Rock



Dış Cephe İçin Uygundur
Güneşe Dayanır
Suitable for External Facade

SERTİFİKALARIMIZ
CERTIFICATES



Darbeye Dayanır
40 Ton
Impact Resistant
40 Tonne



Eğilime Dayanır
5 Ton
Flexure Resistance
5 Tonne



Dayanıklı Ön Zeh
Durable Front Armor



Ayarlı Menteşe
Adjustable Hinge



Çevre Dostu
Eco - Friendly



Çalınmaya Karşı
Dayanıklı Yüzey
Surface Resistance
To Scratching



E60, E64S
E60 - E64S



Neme Dayanıklıdır
Resistant To Moisture



Ses İzolasyonu
Sağlayan Özel Yapı
Provides Sound Insulation
Special Structure That



Isı İzolasyonu
Sağlayan Özel Yapı
Thermoresistant Heat
Resistance Isolation
Special Structure That



Rüzgarla Dayanıklı
Resistance to wind load



1,2 mm Yekpare Galvaniz Çelik
1,2 mm Monolith Plates Galvanized Steel

42 Densite Poliüretan Dolgu
Filled by 42 Density Polyurethane

1,2 mm Yekpare Galvaniz Çelik
1,2 mm Monolith Plates Galvanized Steel

Dış Tarafı Özel Modelli MDF Yüzey
Outside Special Modeling MDF Surface

Kanat Etrafı Özel Eloksallı Alüminyum Çıta
Around Door Leaf is Designed by Special Anodized Aluminium



ELT 105
Elit Serisi
Semi Fugalı Tütün
Semi Fuga Tobacco

KASA
- 2 mm galvaniz çelik
- 18 - 24 cm duvar kalınlığı
- 24 cm üzeri özel üretim
- Elektrostatik toz boya

OPSİYONEL
- Tuana & Ahşap kasa kaplama seçeneği
- Kasa içi dekoratif eloksallı alüminyum profil

KANAT
- 1,2 mm x2 yekpare galvaniz çelik
- Çelik üzeri özel modellenmiş MDF yüzey
- 42 densite poliüretan dolgu
- Kancalı Kilit sistemi
- 3 adet sabit emniyet pimi
- Gizli emniyet kelepçesi
- Özel tasarım ahşap kol
- Kanat etrafı dekoratif eloksallı alüminyum çıta
- Geniş açılı lüks dürbün
- Kaynaksız ayarlı menteşe
- Kanat Kalınlığı 92 mm

DOOR FRAME
- It is made from 2 mm galvanized steel
- Frame can be adjusted to 18 cm - 24 cm wall thickness
- Special manufacturing for over 24 cm
- Electrostatic powder paint

OPTIONAL
- Tuana & Wooden Frame coating can be done
- Inside door frame can be done decorative aluminium eloxal profile

DOOR LEAF
- It is made from 1,2 mm two monolith plates galvanized steel
- Special modelling MDF coating over front steel leaf
- Inside door leaf is filled by 42 density polyurethane
- Hook locking system
- 3 pieces stable safety pin
- Hidden safety clips
- Special designed wooden door handle
- Luxury peephole
- Weldless adjustable hinges
- Around door leaf is designed by special anodized aluminium
- Leaf Thickness 92 mm



ELT 110
Elit Serisi
verox
verox

KASA

- 2 mm galvaniz çelik
- 18 - 24 cm duvar kalınlığı
- 24 cm üzeri özel üretim
- Elektrostatik toz boya

OPSİYONEL

- Tuana & Ahşap kasa kaplama seçeneği
- Kasa içi dekoratif eloksallı alüminyum profil

KANAT

- 1,2 mm x2 yekpare galvaniz çelik
- Çelik üzeri doğal ahşap görünümlü laminant yüzey
- 42 densite poliüretan dolgu
- Kancalı Kilit sistemi
- 3 adet sabit emniyet pimi
- Gizli emniyet kelepçesi
- Krom yada alüminyum elektrostatik boyalı çekme kolu
- Kanat etrafı dekoratif eloksallı alüminyum çita
- Geniş açılı lüks dürbün
- Kaynaksız ayarlı menteşe
- Kanat Kalınlığı 92 mm

DOOR FRAME

- It is made from 2 mm galvanized steel
- Frame can be adjusted to 18 cm - 24 cm wall thickness
- Special manufacturing for over 24 cm
- Electrostatic powder paint

OPTIONAL

- Tuana & Wooden frame coating can be done
- Inside the door frame can be done decorative aluminium eloxal profile

DOOR LEAF

- It is made from 1,2 mm two monolith plates galvanized steel
- The natural similar wood finish on the steel surface
- Inside door leaf is filled by 42 density polyurethane
- Hook locking system
- 3 pieces stable safety pin
- Hidden safety clips
- Chrome or aluminium electrostatic painted pull handle
- Luxury peephole
- Weldless adjustable hinges
- Around the door leaf is designed by special anodized aluminium
- Leaf Thickness 92 mm

ELT 106
Elit Serisi

Semi Antrasit Fugalı Tütün
Anthracite Fuga Tobacco

KASA

- 2 mm galvaniz çelik
- 18 - 24 cm duvar kalınlığı
- 24 cm üzeri özel üretim
- Elektrostatik toz boya

OPSİYONEL

- Tuana & Ahşap kasa kaplama seçeneği
- Kasa içi dekoratif eloksallı alüminyum profil

KANAT

- 1,2 mm x2 yekpare galvaniz çelik
- Çelik üzeri doğal ahşap görünümlü laminant yüzey
- 42 densite poliüretan dolgu
- Kancalı Kilit sistemi
- 3 adet sabit emniyet pimi
- Gizli emniyet kelepçesi
- Krom yada alüminyum çekme kolu
- Kanat etrafı dekoratif eloksallı alüminyum çita
- Geniş açılı lüks dürbün
- Kaynaksız ayarlı menteşe
- Kanat Kalınlığı 92 mm

DOOR FRAME

- It is made from 2 mm galvanized steel
- Frame can be adjusted to 18 cm - 24 cm wall thickness
- Special manufacturing for over 24 cm
- Electrostatic powder paint

OPTIONAL

- Tuana & Wooden frame coating can be done
- Inside the door frame can be done decorative aluminium eloxal profile

DOOR LEAF

- It is made from 1,2 mm two monolith plates galvanized steel
- The natural similar wood finish on the steel surface
- Inside door leaf is filled by 42 density polyurethane
- Hook locking system
- 3 pieces stable safety pin
- Hidden safety clips
- Chrome or aluminium door handle
- Luxury peephole
- Weldless adjustable hinges
- Around the door leaf is designed by special anodized aluminium
- Leaf Thickness 92 mm





ELT 102
Elit Serisi
Zen HG Tütün Siyah
Zen Tobacco Black

ELT 101
Elit Serisi
Zen Tütün
Zen Tobacco



KASA

- 2 mm galvaniz çelik
- 18 - 24 cm duvar kalınlığı
- 24 cm üzeri özel üretim
- Elektrostatik toz boya

OPSIYONEL

- Tuana & Ahşap kasa kaplama seçeneği
- Kasa içi dekoratif eloksallı alüminyum profil

KANAT

- 1,2 mm x2 yeypare galvaniz çelik
- Çelik üzeri özel Parçalı MDF yüzey
- 42 densite poliüretan dolgu
- Kancalı Kilit sistemi
- Dekoratif Alüminyum çita detayı
- 3 adet sabit emniyet pimi
- Gizli emniyet kelepçesi
- 50 cm krom yada alüminyum kol
- Kanat etrafı dekoratif eloksallı alüminyum çita
- Geniş açılı lüks dürbün
- Kaynaksız ayarlı menteşe
- Kanat Kalınlığı 92 mm

* MDF üzeri HG PVC lamine kaplama (ELT 102)

DOOR FRAME

- It is made from 2 mm galvanized steel
- Frame can be adjusted to 18 cm - 24 cm wall thickness
- Special manufacturing for over 24 cm
- Electrostatic powder paint

OPTIONAL

- Tuana & Wooden frame coating can be done
- Inside the door frame can be done decorative aluminium eloxal profile

DOOR LEAF

- It is made from 1,2 mm two monolith plates galvanized steel
- Special pieced modelling MDF surface over front steel leaf
- Inside door leaf is filled by 42 density polyurethane
- Decorative Aluminium lath detail
- Hook locking system
- 3 pieces stable safety pin
- Hidden safety clips
- Chrome or aluminium 50cm door handle
- Luxury peephole
- Weldless adjustable hinges
- Around the door leaf is designed by special anodized aluminium
- Leaf Thickness 92 mm

* MDF with HG PVC lamination coating (ELT 102)



ELT 103
Elit Serisi
Semi Wood Tütün
Semi Wood Tobacco

KASA

- 2 mm galvaniz çelik
- 18 - 24 cm duvar kalınlığı
- 24 cm üzeri özel üretim
- Elektrostatik toz boya

OPSİYONEL

- Tuana & Ahşap kasa kaplama seçeneği
- Kasa içi dekoratif eloksallı alüminyum profil

KANAT

- 1,2 mm x2 yeypare galvaniz çelik
- Çelik üzeri özel modellenli MDF yüzey
- 42 densite poliüretan dolgu
- Kancalı Kilit sistemi
- 3 adet sabit emniyet pimi
- Gizli emniyet kelepçesi
- 120 cm krom yada alüminyum kol
- Kanat etrafı dekoratif eloksallı alüminyum çıta
- Geniş açılı lüks dürbün
- Kaynaksız ayarlı menteşe
- Kanat Kalınlığı 92 mm

DOOR FRAME

- It is made from 2 mm galvanized steel
- Frame can be adjusted to 18 cm - 24 cm wall thickness
- Special manufacturing for over 24 cm
- Electrostatic powder paint

OPTIONAL

- Tuana & Wooden Frame coating can be done
- Inside door frame can be done decorative aluminium eloxal profile

DOOR LEAF

- It is made from 1,2 mm two monolith plates galvanized steel
- Special modelling MDF coating over front steel leaf
- Inside door leaf is filled by 42 density polyurethane
- Hook locking system
- 3 pieces stable safety pin
- Hidden safety clips
- Chrome or aluminium door handle (120 cm)
- Luxury peephole
- Weldless adjustable hinges
- Around door leaf is designed by special anodized aluminium
- Leaf Thickness 92 mm

ELT 104
Elit Serisi
Semi Wood Modern ceviz
Semi Wood Modern Walnut

KASA

- 2 mm galvaniz çelik
- 18 - 24 cm duvar kalınlığı
- 24 cm üzeri özel üretim
- Elektrostatik toz boya

OPSİYONEL

- Tuana & Ahşap kasa kaplama seçeneği
- Kasa içi dekoratif eloksallı alüminyum profil

KANAT

- 1,2 mm x2 yeypare galvaniz çelik
- Çelik üzeri özel modellenli MDF yüzey
- 42 densite poliüretan dolgu
- Kancalı Kilit sistemi
- 3 adet sabit emniyet pimi
- Gizli emniyet kelepçesi
- 120 cm krom yada alüminyum kol
- Kanat etrafı dekoratif eloksallı alüminyum çıta
- Geniş açılı lüks dürbün
- Kaynaksız ayarlı menteşe
- Kanat Kalınlığı 92 mm

DOOR FRAME

- It is made from 2 mm galvanized steel
- Frame can be adjusted to 18 cm - 24 cm wall thickness
- Special manufacturing for over 24 cm
- Electrostatic powder paint

OPTIONAL

- Tuana & Wooden Frame coating can be done
- Inside door frame can be done decorative aluminium eloxal profile

DOOR LEAF

- It is made from 1,2 mm two monolith plates galvanized steel
- Special modelling MDF coating over front steel leaf
- Inside door leaf is filled by 42 density polyurethane
- Hook locking system
- 3 pieces stable safety pin
- Hidden safety clips
- Chrome or aluminium door handle (120 cm)
- Luxury peephole
- Weldless adjustable hinges
- Around door leaf is designed by special anodized aluminium
- Leaf Thickness 92 mm



SUNNY UV GLASS



SNY UV 101
Sunny UV Glass Serisi
Sara UV Kum Gri
Sara UV Grey Sand

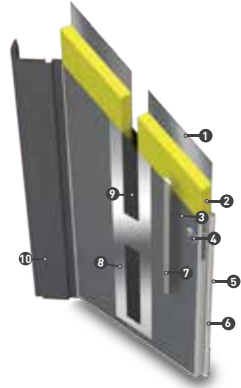

- 1 1,2 mm Yekpare Galveniz Çelik
1,2 mm Monolith Plates Galvanized Steel
- 2 42 Densite Poliüretan Dolgu
Filled by 42 Density Polyurethane
- 3 1,2 mm Yekpare Galveniz Çelik
1,2 mm Monolith Plates Galvanized Steel
- 4 Dayanıklı Ön Zırh
Durable Front Armor
- 5 Kanat Etrafı Elokssaltlı Alüminyum Çıta
Around Door Leaf is Designed by
Special Anodized Aluminum
- 6 İzolasyon Filtiri
Insulation Seal
- 7 Alüminyum Çekme Kol
Aluminum Pull Handle
- 8 Krom Çerçeve Detayı
Chrome Frame Detail
- 9 Işık Geçirgen Temperli Reflekte Cam
Light Permeable Tempered Reflective Glass
- 10 2 mm Galvaniz Çelik
Standart Elektrostatik Toz Boya
2 mm galvanized steel
Electrostatic powder paint

Sunny UV Glass serisi tek kanat ve Çift kanat olarak üretilmektedir.

Kilit özelliği Kanat tipine göre farklılık göstermektedir.

(*)Tek kanat da kanca kilit sistemi ve Gizli Emniyet Kelepçesi Kullanılır.

(**) Çift kanat da Monoblok Kilit sistemi kullanılır. G.E.K. KULLANILAMAZ

Sunny UV Glass serie can be manufactured as single leaf and double leaf.
Lock specifications will be different according to leaf type.

(*)On single leaf locking system, hook locking system and hidden safety clip is used.

(**)On double leaf locking system, monoblok locking system is used.
Hidden safety clip is not used.



Glass Type

Sunny UV Glass Serisi
-Işık geçirgen temperli
reflekte cam

-Light permeable
tempered reflective
glass



SNY UV 101
Sunny UV Glass Serisi
Sara UV Beyaz
Sara UV White



SNY UV 101
Sunny UV Glass Serisi
Sara UV Antrasit
Sara UV Anthracite

KASA

- 2 mm galvaniz çelik
- 18 - 24 cm duvar kalınlığı
- 24 cm ve üzeri özel ölçü
- Standart elektrostatik toz boya

OPSİYONEL

- Alüminyum ve Tuana kasa kaplama seçeneği
- Kasa içi dekoratif eloksallı alüminyum seçeneği

KANAT

- 1,2 mm X 2 yekpare galvaniz çelik
- Özel çelik üzeri PVC lamine yüzey ve krom detay ile yansıtıcı cam
- 42 densite poliüretan dolgu
- 3 adet sabit emniyet pimi
- Gizli emniyet kelepçesi(*)
- Kanca kilit sistemi(**)
- Geniş açılı Lüks dürbün
- Krom yada Alüminyum çekme kol
- Kanat etrafı dekoratif eloksallı alüminyum çıta
- Kanat Kalınlığı 78 mm

CAM

- 6+52+6 Reflekte ışık geçirgen cam.



SNY UV 101
Sunny UV Glass Serisi
Sara UV Altın Meşe
Sara UV Golden Oak



DOOR FRAME

- It is made from 2 mm galvanized steel
- Frame can be adjusted to 18 cm - 24 cm wall thickness
- Special manufacturing for over 24 cm
- Electrostatic powder paint

OPTIONAL

- Aluminium frame coating and Tuana coating can be done

- Inside frame has decorative eloxal aluminium profile can be done

DOOR LEAF

- It is made from 1,2 mm two monolith plates galvanized steel
- Special PVC laminated surface with chrome detail and transparent glass
- Inside door leaf is filled by 42 density polyurethane
- Hook locking system
- 3 pieces stable safety pin
- Hidden safety clips
- Chrome or aluminium door handle
- Luxury peephole
- Weldless adjustable hinges
- Around door leaf is designed by special anodized aluminium
- Leaf Thickness 78 mm

GLASS

- 6+52+6 Light permeable tempered reflective glass

SERTİFİKALARIMIZ
CERTIFICATES



SUNNY UV GLASS



SNY UV 103
Sunny UV Glass Serisi
Diana Double
Diana UV Antrasit
Diana UV Anthracite



SNY UV 103
Sunny UV Glass Serisi
Diana
UV Antrasit
UV Anthracite



SERTİFİKALARIMIZ
CERTIFICATES





1,2 mm Yekpare Galvaniz Çelik 1,2 mm Monolith Plates Galvanized Steel

42 Densite Poliüretan Dolgu
Filled by 42 Density Polyurethane

1,2 mm Yekpare Galvaniz Çelik
1,2 mm Monolith Plates Galvanized Steel

UV Korumalı Özel Lamine Yüzey
Special UV Protected Laminated Surface

Kanat Etrafı Özel Eloksallı Alüminyum Çıta
Around Door Leaf is Designed by Special Anodized Aluminum



UV 101

UV Serisi

Akik UV Koyu Meşe
Akik UV Dark Oak



Dış Cephe İçin Uygundur
Güneşe Dayanır
Suitable for Exterior Facade

KASA

- 2mm galvaniz çelik
- 18 - 24 cm duvar kalınlığı
- 24 cm üzeri opsiyonel
- Elektrostatik toz boya

OPSİYONEL

- Tuana & Ahşap kasa kaplama seçeneği
- Kasa içi dekoratif eloksallı alüminyum profil çıta seçeneği

KANAT

- 1,2 mm x 2 yekpare galvaniz çelik
- Çelik üzeri özel UV korumalı lamine yüzey (Patentli sistem)
- Özel yüzey modelleme sistemi
- 42 densite poliüretan dolgu
- Kancalı kilit sistemi
- Geniş açılı lüx boru dürbün
- 3 adet sabit emniyet pimi
- Gizli Emniyet Keleğesi
- Krom yada Alüminyum 70 cm boru kol
- Kanat etrafı dekoratif eloksallı alüminyum çıta
- Kaynaksız ayarlı menteşe
- Kanat Kalınlığı 78 mm

OPSİYONEL

- 8 mm lamine MDF ön yüzey

DOORFRAME

- It is made from 2 mm galvanized steel
- Frame can be adjusted to 18 cm - 24 cm wall thickness
- Special manufacturing for over 24 cm

OPTIONAL

- Tuana & Wooden frame coating can be done optional
- Inside the doorframe decorative aluminium coating is made

DOOR LEAF

- It is made from 1,2 mm two monolith plates galvanized steel
- Special UV protected laminated surface over steel leaf (special patented system)
- Front surface modelling system
- Inside the door leaf is made 42 density polyurethane filling
- Hook locking system
- 3 pieces stable safety pin
- Hidden safety clips
- Chrome or aluminium 70 cm pipe door handle
- Luxury peephole
- Weldless adjustable hinges
- Around the door leaf is designed by Special anodized aluminium
- Leaf Thickness 78 mm

OPTIONAL

- 8 mm Laminated MDF Front surface can be done



TPE
Taraftan
Patentlenmiştir



UV

 falezçelikkapı



UV 102
UV Serisi
Akik UV Altın Meşe
Akik UV Golden Oak



KASA
- 2 mm galvaniz çelik
- 18 -24- cm duvar kalınlığı
- 24 cm üzeri opsiyonel
- Elektrostatik toz boya

OPSİYONEL
- Tuana & Ahşap kasa kaplama seçeneği
- Kasa içi eloksallı dekoratif alüminyum profil

KANAT
- 1,2 mm x 2 yekpare galvaniz çelik
- Çelik üzeri özel UV korumalı lamine yüzey (Patentli özel sistem)
- Özel yüzey modelleme sistemi
- 42 densite poliüretan dolgu
- Kancalı kilit sistemi
- Geniş açılı lüx boru dürbün
- 3 adet sabit emniyet pimi
- Gizli Emniyet Kelepçesi
- Krom yada alüminyum 70 cm boru kol
- Kanat etrafı dekoratif eloksallı alüminyum çıta
- Kaynaksız ayarlı menteşe
- Kanat Kalınlığı 78 mm

OPSİYONEL
8 mm lamine MDF ön yüzey

UV 103
UV Serisi
Akik UV Antrasit
Akik UV Anthracite



DOOR FRAME
- It is made from 2 mm galvanized steel
- Frame can be adjusted to
- 18 cm - 24 cm wall thickness
- Special manufacturing for over 24 cm

OPTIONAL
- Tuana & Wooden frame coating can be done optional.
- Inside the doorframe decorative aluminium coating is made

DOOR LEAF
-It is made from 1,2 mm two monolith plates galvanized steel
- special UV protected laminated surface over steel leaf (special patented system)
- Front surface modelling system
- Inside the door leaf is made 42 density polyurethane filling
- Hook locking system
- 3 pieces stable safety pin
- Hidden safety clips
- Chrome or aluminium 70 cm pipe door handle
- Luxury peephole
- Weldless adjustable hinges
- Around the door leaf is designed by Special anodized aluminium
- Leaf Thickness 78 mm

OPTIONAL
- 8mm special MDF Front surface can be done



SN 508
UV Antrasit Gri
UV Anthracite
Grey



ST 501
UV Koyu Meşe
UV Dark Oak



ST 510
UV Siyah
UV Black



ST 517
UV Beyaz
UV White



ST 500
UV Altın Meşe
UV Golden Oak



SERTİFİKALARIMIZ
CERTIFICATES



UV VILLA

SH VL 101
Super Home Villa



Dış Cephe İçin Uygundur
Güneşe Dayanır
Suitable for Exterior Facade



TEK KANATLI KAPI ÖZELLİKLERİ SINGLE LEAF DOOR FEATURES



KASA

- 2 mm galvaniz çelik
- 18-24- cm duvar kalınlığı
- 24cm üzeri özel imalat
- Elektrostatik toz boya

CAM

- 6+18+6 Temperli boyalı vitray
- clear ısıcam

OPSİYONEL

- Tuana, Ahşap yada Eloksallı alüminyum kasa kaplama seçeneği
- Kasa içi dekoratif eloksallı alüminyum profille

KANAT

- 1,2 mm x 2 yekpare galvaniz çelik
- Çelik üzeri özel UV korumalı lamine yüzey (patentli sistem)
- 42 densite poliüretan dolgu
- Kancalı kilit sistemi,
- Geniş açılı lüx boru dürbün
- 3 adet sabit emniyet pimi
- Krom yada alüminyum kol
- Kanat etrafı dekoratif eloksallı alüminyum çıta Kaynaksız ayarlı menteşe 30 mm lamine temperli ısı cam
- Kanat Kalınlığı 78 mm

DOOR FRAME

- It is made from 2 mm galvanized steel
- Frame can be adjusted to
- 18 cm - 24 cm wall thickness
- Special manufacturing for over 24 cm
- Electrostatic powder paint

Glass

- 6+18+6 tempered painted stained clear double glazing

OPTIONAL

- Tuana & Wooden frame coating can be done optinal

- Inside doorframe can be done decorative aluminium profile

DOOR LEAF

- It is made from 1,2 mm two monolith plates galvanized steel
- special laminated UV protected surface over steel leaf (Special patented)
- Inside door leaf is filled 42 density polyurethane
- Hook locking system
- 3 pieces stable safety pin
- Hidden safety clips
- Chrome or aluminium door Handle
- Weldless adjustable hinges
- Around door leaf is designed by special anodized aluminium
- Leaf Thickness 78 mm

UV Kaplamalar benzersiz kreasyonlar ve yaratıcı tasarımların çözümleri sunar, Doğadan ilham alan renk ve yüzey seçenekleri sunar.

UV Coatings offer unique creations and creative design solutions It offers colour and surface options inspired by nature.

UV Villa serisi tek kanat, çift kanat ve yantaraf sabit camlı olarak üretilebilmektedir. Kilit özelliği Kanat tipine göre farklılık göstermektedir.

(*)Tek kanat ve sabit camlı kapılarda da kanca kilit sistemi ve Gizli Emniyet Kelepçesi Kullanılır.

(**) Çift kanat da Monoblok Kilit sistemi kullanılır.

G.E.K. KULLANILAMAZ

UV Villa serie can be manufactured as single leaf, double leaf and fixed glass. Lock specifications will be difference according to leaf type.

(**)On double leaf, locking system Monoblock locking system is used. **Hidden safety clip is not used.**

(*)On single leaf and fixed glass doors, hook locking system and Hidden safety clip is used.

UV DBL 104
Düz UV Koyu Meşe Camlı Kasa
Flat UV Dark Oak Glass Frame



Dış Cephe İçin Uygundur
Güneşe Dayanır
Suitable for Exterior Facade



UV DBL 103
Düz UV Koyu Meşe Kasa
Flat UV Dark Oak Glass Frame



Dış Cephe İçin Uygundur
Güneşe Dayanır
Suitable for Exterior Facade



UV VL 101
Düz UV Koyu Meşe
Flat Dark Oak



Dış Cephe İçin Uygundur
Güneşe Dayanır
Suitable for Exterior Facade



ST 508
UV Antrasit Gri
UV Anthracite
Grey



ST 501
UV Koyu Meşe
UV Dark Oak



ST 510
UV Siyah
UV Black



ST 517
UV Beyaz
UV White



ST 500
UV Altın Meşe
UV Golden Oak

Exterior / 200 Micron
Dişmekan / 200 Micron

Properties

Thickness of the Acrylic Layer
UV folyo kalınlığı

Methods

Value

> 50 µ

Thickness (Only for plain films, not embossed)
Kalınlık (Sadece düz filmler için)

DIN EN ISO
2286-3, 1998-07

200 µ , ± 8 µ

Colour Tolerances for Plain Films
Düz filmler için renk toleransları

DIN 53236 (45/0),
1983-01

ΔE ≤ 0,6 ΔL ≤ 0,35 Δa ≤ 0,30 Δb ≤ +/-0,35

Colour Consistency of Printed Films
UV folyo renk tutarlılığı

Manufacture and visual assessment
with original specimen.
Orjinal numune ile üretim tutarlılığı

SERTİFİKALARIMIZ
CERTIFICATES



Darbeye Dayanır
40 Ton
Impact Resistant
40 Tonne



Eğilmeye Dayanır
5 Ton
Pressure Endurance
5 Tonne



Dayanıklı Ön Zeh
Double Front Armor



Ayarlı Menteşe
Adjustable Hinge



Çevre Dostu
Eco - Friendly



Çalınmaya Karşı
Dayanıklı Yüzey
Surface Resistance
To Scratchings



CE



E60, E4+5
E60 - E4+5



Neme Dayanıklıdır
Resistant To Moisture



Ses İzolasyonu
Sağlayan Özel Yapı
Special Structure That
Provides Sound Insulation



Isı İzolasyonu
Sağlayan Özel Yapı
Special Structure
Resistant To Heat



Rüzgar Dayanıklı
Resistance to wind load

ELIT SAFIR



SFR 105

Safir Serisi

Lattice Koyu Bambu - HG Beyaz
Lattice Dark Bambu - HG White

KASA

- 2 mm galvaniz çelik
- 18 - 24 cm duvar kalınlığı
- 24 cm üzeri özel imalat
- Elektrostatik toz boya

OPSİYONEL

- Tuana & Ahşap kasa kaplama seçeneği
- Kasa içi dekoratif eloksallı alüminyum profil

KANAT

- 1,2 mm x2 yekpare galvaniz çelik
- Çelik üzeri özel siyah HG lamine kaplama ve ahşap çıta detayı
- 42 densite poliüretan dolgu
- Kancalı Kilit sistemi
- 3 adet sabit emniyet pimi
- Gizli emniyet kelepçesi
- Krom yada alüminyum çekme kolu
- Kanat etrafı dekoratif eloksallı alüminyum çıta
- Geniş açılı lüks dürbün
- Kaynaksız ayarlı menteşe
- Kanat Kalınlığı 78 mm

DOOR FRAME

- It is made from 2 mm galvaniz steel
- Frame can be adjusted to 18 cm - 24 cm wall thickness
- Special manufacturing for over 24 cm
- Electrostatic powder paint

OPTIONAL

- Tuana & Wooden frame coating can be done
- Inside the door frame can be done decorative eloxal aluminium profile

DOOR LEAF

- It is made from 1,2 mm two monolith plates galvanized steel
- HG laminated coating surface and wooden sticks over front steel leaf
- Inside door leaf is filled by 42 density polyurethane
- Hook locking system
- 3 pieces stable safety pin
- Hidden safety clips
- Chrome or aluminium door handle
- Luxury peephole
- Weldless adjustable hinges
- Around the door leaf is designed by special anodized aluminium
- Leaf Thickness 78 mm



SFR 100

Safir Serisi

Karen Siyah Milano Ceviz
Karen Black Milano Walnut

Renk Skalası / Colour Options

Siyah / Black

Beyaz / White

SERTİFİKALARIMIZ
CERTIFICATES



GOLD



GLD 113

Gold Serisi

Akik Soft Touch
Fırtına Gri

Akik Soft Touch
Storm Grey

KASA

- 2 mm galvaniz çelik
- 18 - 24 cm duvar kalınlığı
- 24 cm üzeri özel üretim
- Elektrostatik toz boya

OPSİYONEL

- Tuana yada Ahşap kasa kaplama opsiyonel
- Kasa içi dekoratif eloksallı alüminyum profil

KANAT

- 1,2 mm x2 yekpare galvaniz çelik
- Çelik üzeri Soft Touch lamine yüzey ile lakeye dokunuyor hissi verir (patentli özel sistem)
- Özel yüzey modelleme sistemi
- 42 densite poliüretan dolgu
- Kancalı kilit sistemi
- Geniş açılı lüks boru dürbün
- 3 adet sabit emniyet pimi
- Gizli emniyet kelepçesi
- Krom yada alüminyum 70 cm çekme kolu
- Kanat etrafı dekoratif eloksallı alüminyum çita
- Kaynaksız ayarlı menteşe
- Kanat Kalınlığı 78 mm

OPSİYONEL

- 8 mm lamine MDF ön yüzey

DOOR FRAME

- It is made from 2 mm galvaniz steel
- Frame can be adjusted to 18 cm - 24 cm
- Special manufacturing for over 24 cm
- Electrostatic powder paint

OPTIONAL

- Tuana & Wooden frame coating can be done
- Inside door frame can be done decorative eloxal aluminium profile

DOOR LEAF

- It is made from 1,2 mm two monolith plates galvanized steel
- It gives the feeling of touching the lacquer with Soft touch laminated surface on steel.
- Front surface modelling system
- Inside door leaf is filled by 42 density polyurethane
- Hook locking system
- 3 pieces stable safety pin
- Hidden safety clips
- Chrome or aluminium 70 cm cylinder door handle
- Luxury peephole
- Weldless adjustable hinges
- Around the door leaf is designed by special anodized aluminium
- Leaf Thickness 78 mm

OPTIONAL

- 8 mm special MDF front surface can be done

GLD 120

Gold Serisi
Serra | Serra



SERTİFİKALARIMIZ
CERTIFICATES



SILVER



SLV 103

Silver Serisi
Silver Berry Lake Beyaz
Silver Berry Lake White

KASA

- 2 mm galvaniz çelik
- 18 - 24 cm duvar kalınlığı
- 24 cm üzeri özel üretim
- Elektrostatik toz boya

OPSİYONEL

- Tuana yada Ahşap kasa kaplama opsiyonel
- Kasa içi dekoratif eloksallı alüminyum profil

KANAT

- 1,2 mm x2 yeckpare galvaniz çelik
- Çelik üzeri özel modellenli silver lake beyaz lamine yüzey (patentli özel sistem)
- Özel Yüzey Modelleme sistemi
- 42 densite poliüretan dolgu
- Kancalı kilit sistemi
- Geniş açılı lüks boru dürbün
- 3 adet sabit emniyet pimi
- Gizli emniyet kelepçesi
- Krom yada alüminyum 70 cm çekme kolu
- Kanat etrafı dekoratif eloksallı alüminyum çita
- Kaynaksız ayarlı menteşe
- Kanat Kalınlığı 78 mm

OPSİYONEL

- 8 mm lamine MDF ön yüzey

DOOR FRAME

- It is made from 2 mm galvanized steel
- Frame can be adjusted to 18 cm - 24 cm wall thickness
- Special manufacturing for over 24 cm
- Elektrostatic powder paint

OPTIONAL

- Tuana & Wooden frame coating can be done
- Inside the door frame can be done decorative eloxal aluminium profile

DOOR LEAF

- It is made from 1,2 mm two monolith plates galvanized steel
- Silver lake white laminated surface over front steel leaf (special patented system)
- Front surface modelling system
- Inside door leaf is filled with 42 density polyurethane
- Hook locking system
- 3 pieces stable safety pin
- Hidden safety clips
- Chrome or aluminium 70 cm cylinder door handle
- Luxury peephole
- Weldless adjustable hinges
- Around door leaf is designed by special anodized aluminium
- Leaf Thickness 78 mm

OPTIONAL

- 8 mm special MDF front surface can be done

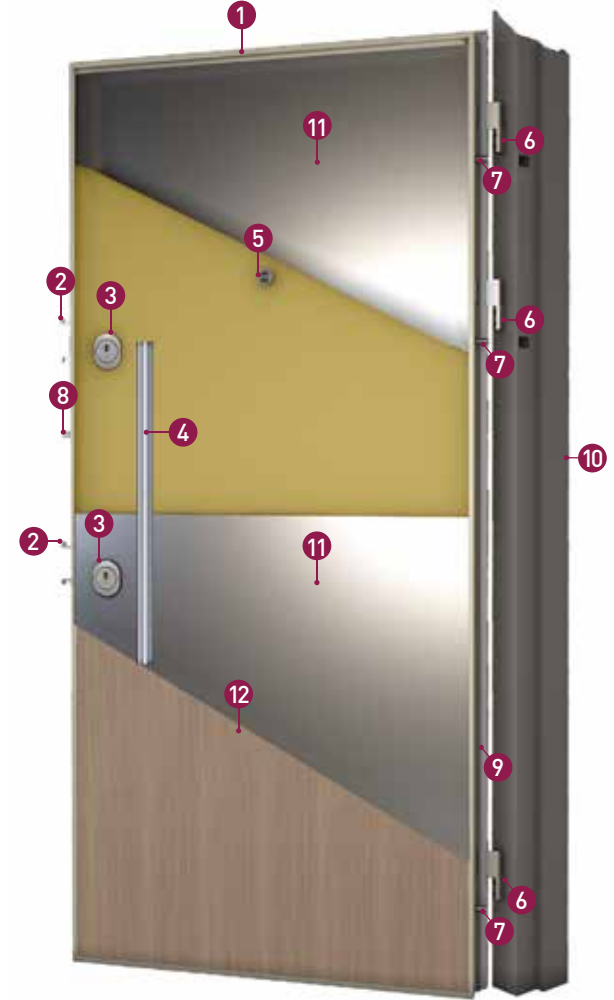

1 Kanat etrafı eloksallı alüminyum çita
Anodized Aluminum Profile Around the Door Leaf

2 Kancalı Kilit
Hook Locking System

3 Darbelere karşı dayanıklı özel zırh
Impact resistant special armor

4 Pazarlanmaz alüminyum çekme
Stainless aluminum extrusion

5 Lüks gözletme dürbünü
luxury binoculars

6 Ayarlanabilir menteşe
Adjustable hinge

7 Sabit emniyet pimi
Fixed safety pin

8 Gizli emniyet pimi
Hidden safety pin

9 izolasyon fitili
Insulation wick

10 2 mm Galvaniz çelik kasa
2 mm Galvanized steel frame

11 1.2 mm Galvaniz yeckpare galvaniz çelik
1.2 mm Solid galvanized steel

12 Çelik üstü özel SILVER yüzey
Special silver laminated surface over front steel

SERTİFİKALARIMIZ
CERTIFICATES



SILVER



SLV 104

Silver Serisi
Star Beyaz
Star White

KASA

- 2 mm galvaniz çelik
- 18 - 24 cm duvar kalınlığı
- 24 cm üzeri özel üretim
- Elektrostatik toz boya

OPSİYONEL

- Tuana yada Ahşap kasa kaplama opsiyonel
- Kasa içi dekoratif eloksallı alüminyum profil

KANAT

- 1,2 mm x2 yekpare galvaniz çelik
- Çelik üzeri özel modelli Silver lamine yüzey (patentli özel sistem)
- Özel Yüzey Modelleme sistemi
- 42 densite poliüretan dolgu
- Kancalı kilit sistemi
- Geniş açılı lüks boru dürbün
- 3 adet sabit emniyet pimi
- Gizli emniyet kelepçesi
- Krom yada alüminyum 70 cm çekme kolu
- Kanat etrafı dekoratif eloksallı alüminyum çita
- Kaynaksız ayarlı menteşe
- Kanat Kalınlığı 78 mm

OPSİYONEL

- 8 mm lamine MDF ön yüzey

DOOR FRAME

- It is made from 2 mm galvanized steel
- Frame can be adjusted to 18 cm - 24 cm wall thickness
- Special manufacturing for over 24 cm
- Elektrostatic powder paint

OPTIONAL

- Tuana & Wooden frame coating can be done
- Inside the door frame can be done decorative eloxal aluminium profile

DOOR LEAF

- It is made from 1,2 mm two monolith plates galvanized steel
- Special silver laminated surface over front steel leaf (special patented system)
- Front surface modelling system
- Inside door leaf is filled by 42 density polyurethane
- Hook locking system
- 3 pieces stable safety pin
- Hidden safety clips
- Chrome or aluminium 70 cm cylinder door handle
- Luxury peephole
- Weldless adjustable hinges
- Around door leaf is designed by special anodized aluminium
- Leaf Thickness 78 mm

OPTIONAL

- 8 mm special MDF front surface can be done

SLV 116

Silver Serisi
Premium Gümüş
Premium Silver



TPE
Tarafından
Patentlenmiştir

SERTİFİKALARIMIZ
CERTIFICATES



SILVER



SLV 115
Silver Serisi
Premium Bakır
Premium Copper



SLV 105
Silver Serisi
Akik Tütün
Akik Tobacco

SERTİFİKALARIMIZ
CERTIFICATES



SILVER



SLV 102
Silver Serisi
Akik Cocco
Akik Cocco

KASA

- 2 mm galvaniz çelik
- 18 - 24 cm duvar kalınlığı
- 24 cm üzeri özel üretim
- Elektrostatik toz boya

OPSİYONEL

- Tuana yada Ahşap kasa kaplama opsiyonel
- Kasa içi dekoratif eloksallı alüminyum profil

KANAT

- 1,2 mm x2 yekpare galvaniz çelik
- Çelik üzeri özel modelli silver lamine yüzey (patentli özel sistem)
- 42 densite poliüretan dolgu
- Kancalı kilit sistemi
- Geniş açılı lüks boru dürbün
- 3 adet sabit emniyet pimi
- Gizli emniyet kelepçesi
- Krom yada alüminyum 70 cm çekme kolu
- Kanat etrafı dekoratif eloksallı alüminyum çita
- Kaynaksız ayarlı menteşe
- Kanat Kalınlığı 78 mm

OPSİYONEL

- 8 mm lamine MDF ön yüzey



TPE
Tarafından
Patentlenmiştir

SLV 101
Silver Serisi
Kehribar Modern Ceviz
Kehribar Modern Walnut

DOOR FRAME

- It is made from 2 mm galvanized steel
- Frame can be adjusted to 18 cm - 24 cm wall thickness
- Special manufacturing for over 24 cm
- Elektrostatic powder paint

OPTIONAL

- Tuana & Wooden frame coating can be done
- Inside the door frame can be done decorative eloxa aluminium profile

DOOR LEAF

- It is made from 1,2 mm two monolith plates galvanized steel
- Special silver laminated surface over front steel leaf (special patented system)
- Front surface modelling system
- Inside door leaf is filled by 42 density polyurethane
- Hook locking system
- 3 pieces stable safety pin
- Hidden safety clips
- Chrome or aluminium 70 cm cylinder door handle
- Luxury peephole
- Weldless adjustable hinges
- Around door leaf is designed by special anodized aluminium
- Leaf Thickness 78 mm

OPTIONAL

- 8 mm special MDF front surface can be done



SILVER



SLV 107
Silver Serisi
Kehribar Tütün
Kehribar Tobacco



SLV 108
Silver Serisi
Akik Beyaz
Akik White



SLV 109
Silver Serisi
Tire Teak
Tire Teak

SERTİFİKALARIMIZ
CERTIFICATES



40 Tonne



5 Tonne



Adjustable Hinge



Eco - Friendly



Çalınmaya Karşı Dayanıklı Yüzey Surface Resistance To Scratching



600 - E64S



Resistant To Moisture



Special Structure That Provides Sound Insulation



Resistance to wind load



TEKNİK KAPILAR TECHNICAL DOORS

Kapılarımızın sahip olduğu sertifikalar

Certificates of our doors

EI2 90
E180
E 120



TKN 101
YangınKapısı
Fire Door
Duble Düz Krem
Double Flat Cream



TKN 102
Şaft Kapığı Tekli Krem
Shaft Cover Single Leaf
Cream
5113.58



TKN 103
Teknik Odası Kapısı
Technical Room Door
Düz Krem - Flat Cream
4313.58



TKN 104
Yangın Kapısı - Fire Door Yavru
Kanatlı Düz Krem
Small Door Leaf Flat Cream



TKN 105
Yangın Kapısı - Fire Door Tekli
Düz Kırmızı
Single Leaf Kırmızı

TEKNİK KAPILAR TECHNICAL DOORS



TKN 106
Yangın Kapısı - Fire Door
Yavru Kanatlı Camlı Antrasit
Small Door Leaf With Glass Anthracite

TKN 107
Yangın Kapısı - Fire Door
Tek Kanatlı Camlı Antrasit
Single Leaf with Glass Anthracite



TKN 109
Teknik Odası Kapısı
Tek Menfez

Technical
Room Door
Single Vent

Düz Krem -
Flat Cream
4313.58



TKN 108
Teknik Odası Kapısı
Çift Menfez

Technical Room Door
Double Vent

Düz Krem
Flat Cream

4313.58

TKN 120
Menfezli Teknik oda kapısı
Steel Door With Aluminium Louver
Single Leaf Anthracite



Teknik Oda Kapıları Genel Özellikler

- Kasa**
 - 2 mm galvaniz çelik
- Kanat**
 - 1mm x2 yekpare galvaniz çelik
- Boya Teknolojisi**
 - Çift katman Epoksi astar ve texture elektro statik boya
- Kanat İç Malzemeleri (Sertifikalarına göre)**
 - Taş yünü
 - Seramik yünü
 - Alçıpan
- Opsiyonel Aksesuar**
 - Alüminyum menfez
 - İç, dış müdahale kolları
 - Panik bar sistemleri

TKN 121
Çift Kanatlı Menfezli Teknik oda kapısı
Double Leaf Steel Door With Aluminium Louver
Anthracite



Technical Room Doors General Features

- DOOR FRAME**
 - 2 mm Galvanized Steel
- Door Leaf**
 - It is made from 1 mm two monolith plates galvanized steel
- Paint Technology**
 - Double layer Epoxy primer and texture electrostatic paint
- Leaf Inner Materials (According to their certificates)**
 - Rock wool
 - Ceramic wool
 - Drywall
- Optional Accessory**
 - Aluminium louver
 - Interior, external intervention arms
 - Panik bar systems

TKN 122
Teknik Odası Kapısı



Beyaz RAL 9010 renk
20x40 özel alaşımli profil
3 Millî kilit sistemi
Ayarlı menteşe

White RAL 9010 colours
20x40 special alloy profile,
3 shaft locking system
Adjustable hinge

VAULT DOOR

Para Odası Kapısı
Şifre mekanizmalı yangın dayanımlı kasa odası kapısı

Fire resistant safe room door with password mechanism



Beyaz RAL 9010 renk
Valut Mekanizma
4 Yönlü kitleme mekanizma
Özel şifreli anahtar

White RAL 9010 colours
Valut Mechanism
4-way locking mechanism
Private encrypted key



Darbeye Dayanır
40 Ton
Impact Resistant
40 Tonne



Neme Dayanıklıdır
Resistant To Moisture



Dayanıklı Ön Zırh
Durable
Front Armor



Ayarlı Menteşe
Adjustable
Hinge



Çevre Dostu
Eco - Friendly



Çizilmeye Karşı Dayanıklı Yüzey
Surface Resistance
To Scratching

DOUBLE



KASA

- 2 mm galvaniz çelik
- 18 - 24 cm duvar kalınlığı
- 24 cm üzeri özel üretim
- Elektrostatik toz boya

CAM

- 6+18+6 Temperli ısı cam

OPSIYONEL

- Tuana Ahşap kasa kaplama veya Alüminyum geçme
- Kasa içi dekoratif eloksallı alüminyum profil

KANAT

- 1,2 mm x2 yeypare galvaniz çelik
- Çelik üzeri özel UV PVC lamine yüzey
- 42 densite poliüretan dolgu
- Monoblok kilit sistemi
- Geniş açılı lüks boru dürbün
- 3 adet sabit emniyet pimi
- Gizli emniyet kelepçesi
- Krom yada alüminyum kare kol
- Kanat etrafı dekoratif eloksallı alüminyum çıta
- Kaynaksız ayarlı menteşe

DOOR FRAME

- It is made from 2 mm galvanized steel
- Frame can be adjusted to 18 cm 24 cm wall thickness
- Special manufacturing for over 24 cm

GLASS

- 6+18+6 Tempered double glazing

OPTIONAL

- Tuana & Aluminium or Wooden frame coating can be done
- Inside door frame decorative eloxal aluminium profile

DOOR LEAF

- It is made from 1,2 mm two monolith plates galvanized steel
- special UV PVC laminated surface over steel leaf
- Inside door leaf is filled by 42 density polyurethane
- Hook locking system
- 3 pieces stable safety pin
- Chrome or aluminium quadratic door handle
- Luxury peephole
- Weldless adjustable hinges
- Around door leaf is designed by special anodized aluminium

DBL 109

Double Serisi

Akik UV Koyu Meşe | Akik UV Dark Oak



DBL WDN 103

Double Serisi

Noble Doğal Ağaç | Noble Natural Wood



SERTİFİKALARIMIZ
CERTIFICATES



DOUBLE



DBL WDN 104
Marin Doğal Ağaç
Marin Doğal Ağaç | Marin Natural Wood



DBL PR 102
Pierre Serisi
Pierre 102 Antrasit - Cam | Pierre 102 Anthracite - Glass



SERTİFİKALARIMIZ
CERTIFICATES



DOUBLE



DBL PR 120
Pestij Serisi
Diana
7030 Maun
7030 Mahogany



DBL PR 121
Pestij Serisi
Trian
DB 43 Duman Gri
DB 43 Smoke Grey



DB - 95
İnce Ceviz
Nussbaum

DB - 91
İnce Altın Meşe
Fine Wood



DB - 93
Tik
Teak

DB - 94
Açık Altın Meşe
Kiefer Line Wood



DB - 98
Koyu Abanoz
Dark Ebony

DB - 99
Açık Abanoz
Light Ebony



DB - 86
Antik Bambu
Antique Bamboo

DB - 90
Kalın Altın Meşe
Line Wood

SERTİFİKALARIMIZ
CERTIFICATES



BLITZ LOCK

AKILLI KİLİT SİSTEMLERİ

YÜKSEK GÜVENLİKLİ VE AKILLI KİLİT SİSTEMLERİ

ÜRÜN ÖZELLİKLERİ

- Paslanmaz metal aksamlı elektromekanik kapı kilit sistemi.
- Parmak izi, şifre, IC kart, APP ve anahtar olmak üzere 5 fonksiyonlu mekanik silindire ile açılabilen motorlu dış kapı kilidi.
- İçeriden ve dışardan tam otomatik açılma özelliği.
- Elektronik mekanizma ile de kontrol edilen kilit mekanizmalarına ek olarak, sadece içeriden kontrol edilebilen mekanik paslanmaz çelik kilit.
- Yeni teknoloji parmak izi tarayıcı.
- 100 kullanıcı kapasitesi (parmak izi).
- 6-16 haneli şifre.
- Yüksek frekanslı ve kopyalanamaz şifre girişi.
- OLED ekran
- İç ünite üzerinde konumlu, Şarj edilebilir, android girişli, portatif, güçlü batarya
- Dış ünite üzerinde dahili şarj girişi ve şarj durum göstergesi.
- Dahili kapı zili fonksiyonu. - Akıllı sesli yönlendirme ve ikazlar.
- 8.4 V güçlü çelik motor. -4.2 V düşük pil ikaz değeri.
- 10% 85% RH nem dayanımı / -20 +55 derece.
- Okumada hata değeri ≤0.0001% - Okuma hız 300 milisaniye.
- Dahili vizör ve ekran
- Fotoğraf kayıt
- Mikro USB bağlantı noktası
- Şarj edilebilir batarya.

Kilit Açma Yöntemleri



CCSY TAURUS 3 CAT EYES



RENK	: SİYAH
KİLİT BOYUTU	: 410 X 72 MM
DESTEK SİSTEMİ	: IOS 7.0 veya ANDROID 4.4 ÜZERİ
GÜÇ KAYNAĞI	: 7.4V LITYUM PİL
ACİL KİLİT SİLİNDİRİ	: SÜPER C SEVİYESİ KİLİT SİLİNDİRİ
KULLANICI KAPASİTESİ	: 100 ADET PARMAK İZİ / KART / KOD
KAPI KALINLIĞI	: 35 - 120 MM



UYGULAMA
ÜZERİNDEN
YÖNETİM



MANUEL
ANAHTAR



Wi-Fi
BAĞLANTI



OTOMATİK
KİLİT



ÇİFT
KİLİT



SESLİ
KOMUT



PARMAK
İZİ



BATARYA
GÜCÜ İZLEME



ZAMAN
SINIRLI
ŞİFRE



ALARM



KART
İLE
GİRİŞ



AES-R36
ŞİFRELEME



ALUMINYUM KASA KANAT DETAYI

Aluminum Casing & Leaf Details



Wooden, Quartz, Glass ve
Pierre serri kanat profili kesiti

Eli serri kanat profili kesiti

UV, H0, Saliç, Klasik ve Silver
serri kanat profili kesiti

Diş cepheye dayanıklıdır.
Durable for exterior facade

Tuana Kasa Kaplama Montaj Sistemi
Tuana Frame Covering Mounting System



Gizli Emniyet Kepelepçesi
Concealed Safety Bucket



Monoblok
Kilit Sistemi

Monoblock
Lock System



Eko Açma Kolu
Eko Opening Handle



Silver Açma Kolu
Silver Opening Handle



Simge Model Açma Kolu
Simge Model Opening Handle



Merkezi Kilit sistemi
Central Lock System



ÜTOTOPIK
Parmak izi
Tanıma
Sistemi



ÜTOTOPIK
Finger Print
System



Dayanıklı Zırh
Durable armor

Kanca Kilit Sistemi
Hook Lock System



Tak-Tak lı
Dürbün

Lock - Lock
Peephole



Genis Açılı
Lüks Dürbün
Luxury peephole



BAKIRCI LAR ÇELİK KAPI
ALÜ. MOB. MAD. MER. İNŞ. TİC. ve SAN. LTD. ŞTİ.

Genel Müdürlük & Fabrika / Head Office & Factory
Organize Sanayi Yolu Odabaşı Köyü ANTALYA

Tel: +90,242, 424 83 27 - 28 pbx Fax: +90,242, 424 83 29
www.falezcelikkapi.com info@falezcelikkapi.com

444 1 694

Ürün görselleri ileri teknoloji kullanılarak hazırlanmıştır. Çok az da olsa baskıdan veya ekran kalitesinden kaynaklanan piksel ve tipografik hatalar olabilir. Müşterilerimizin bu hususu dikkate almalarını rica ederiz. Falez Çelik Kapi gerektğinde katalogta ya da web sitesinde yayınlanmayan kapı modellerinde ve görsellerinde değişiklik yapma hakkını saklı tutar.